

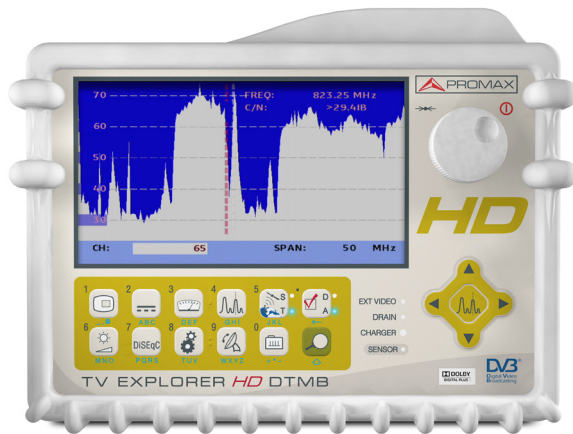

TV EXPLORER *HD* DTMB

UNIVERSAL TV EXPLORER



SAFETY NOTES

Read the user's manual before using the equipment, mainly " SAFETY RULES " paragraph.

The symbol  on the equipment means "SEE USER'S MANUAL". In this manual may also appear as a Caution or Warning symbol.

Warning and Caution statements may appear in this manual to avoid injury hazard or damage to this product or other property.

TABLE OF CONTENTS

1	GENERAL.....	1
1.1	Description	1
1.2	Specifications	4
2	SAFETY RULES.....	11
2.1	General safety rules	11
2.2	Descriptive Examples of Over-Voltage Categories	12
3	INSTALLATION	13
3.1	Power Supply	13
3.1.1	Operation using the External DC Charger	13
3.1.2	Operation using the Battery	13
3.1.2.1	Battery Charging	14
3.2	Installation and Start-up	14
4	QUICK USER GUIDE	15
5	OPERATING INSTRUCTIONS.....	19
5.1	Description of the Controls and Elements.....	19
5.2	Adjustment of Volume and Monitor Parameters.....	29
5.3	Selecting the Operation Mode: TV / Spectrum Analyser / Measurements	29
5.4	Channel Tuning / Frequency Tuning	30
5.5	Automatic Transmission Search.....	30
5.6	Selecting the measurement configuration: Analogue/ Digital signal	30
5.7	External Units Power Supply.....	31
5.8	Automatic signal identification function (AUTO ID)	32
5.9	Channel plans	33
5.10	Acquisition function (DATALOGGER)	35
5.11	Verification of distribution networks.....	38
5.12	Spectrum exploration function (EXPLORER).....	40
5.13	Measurements configuration	41
5.13.1	DVB-C (QAM) Digital Channel Configuration	41
5.13.2	DTMB Digital Channel Configuration	42
5.13.3	DVB-S/S2 (QPSK/8PSK) Digital Channel Configuration	43
5.14	Selecting the Measurements.....	45
5.14.1	Analogue TV: Measuring the Video Carrier Level.....	46
5.14.2	Analogue TV: Measuring the Video / Audio ratio (V/A).....	48
5.14.3	Analogue TV: Measuring the FM deviation.....	48
5.14.4	Analogue FM: Measuring the Level and demodulating signal	49
5.14.5	Analogue/Digital TV: Measuring the Carrier / Noise ratio (C/N).....	50
5.14.6	Digital TV: Measuring the Power of Digital Channels	52
5.14.7	Digital TV: Measuring BER	52
5.14.7.1	ITU-T J.83/B signals	53
5.14.7.2	DVB-C signals.....	54
5.14.7.3	DTMB signals.....	55
5.14.7.4	DVB-S/S2 signals	56
5.14.8	Digital TV: Measuring MER.....	59

5.15	Constellation Diagram	61
5.15.1	ITU-T J.83/B (QAM-Annex B) signal	61
5.15.1.1	Zoom, scroll and erasing functions	62
5.15.2	DTMB signal	63
5.15.3	DVB-C (QAM) signal	64
5.15.4	DVB-S/S2 (QPSK/8PSK) signal.....	64
5.16	Spectrum Analyser	66
5.16.1	Markers	68
5.16.2	Spectrogram.	68
5.16.2.1	Spectrogram Configuration	70
5.16.2.2	Recall a Spectrogram file.....	71
5.16.2.3	Delete a Spectrogram file	72
5.17	ECHOES and PRE-ECHOES Analyser (DTMB).....	72
5.18	Screen capture	75
5.18.1	Recall screen	75
5.18.2	Delete capture.....	76
5.19	PRINT SCREEN function	76
5.20	VIEWPRINT SCREEN	76
5.21	USB On-the-Go Function	77
5.21.1	Connection of TV EXPLORER HD DTMB (host) to a USB flash drive (slave).....	77
5.21.1.1	Connecting a computer (host) to the TV EXPLORER HD DTMB (slave)..	79
5.22	Setting the TS-ASI Input-Output.....	80
5.23	TV Operating Mode	82
5.23.1	Recording and playing video streams.....	86
5.24	Antenna Alignment Function	87
5.25	DiSEqC Command Generator	88
5.26	SATCR function.....	90
5.27	Using the alphanumeric keyboard.....	90
6	DESCRIPTION OF THE INPUTS AND OUTPUTS	93
6.1	RF input.....	93
6.2	TS-ASI Input / Output	93
6.3	USB port	93
6.4	HDMI Conector (High-Definition Multimedia-Interface)	93
6.5	Scart (DIN EN 50049)	94
6.6	Connector for CAM modules and SMART-CARD	95
7	MAINTENANCE.....	97
7.1	Considerations about the Screen	97
7.2	Cleaning Recommendations	97

UNIVERSAL TV EXPLORER TV EXPLORER[®] **HD DTMB**



1 GENERAL

1.1 Description

The television explorer **TV EXPLORER HD DTMB** represents an evolutionary step with respect to the traditional field strength meters. This new jewel of the **PROMAX** range will become a reference in the industry for being the very first meter of its kind to actually meet the requirements to be called a real **HDTV** instrument. The continuous **PROMAX** innovation process in the sector of field strength meter yields an instrument that changes the way to take and understand television signals measurements.

This equipment incorporates important advances in the **functional** aspects as well as in the **ergonomics** to allow the installers to make their work with maximum **comfort** and **speed**. Simultaneously the instrument is **reliable** for any possible problem at the **input signal**, at the **distribution components** or the **receiver equipment**.

Millions of people in Europe are now served with digital TV broadcasting only. Analogue switch off is history for them. For these and those who still are in the migration process from analogue to digital, the use of digital TV distribution equipment will be more frequent every day. The typical high definition formats used in nowadays broadcast are 1080i (1920x1080 pixels) and 720p (1280x720 pixels). Most of the TV programmes using these video resolutions are being broadcasted compressed in MPEG-4. The **TV EXPLORER HD DTMB** is able to display those TV programmes thanks to its state of the art electronics.

HDTV content is expensive to produce and therefore it is usually protected by encryption. Once again the **TV EXPLORER HD DTMB** is setting new standards with its CAM interface that allows the encrypted high definition programmes to be displayed as well.

TV EXPLORER[®] is a registered trademark PROMAX Electronica S.A.



¹ Digital Video Broadcasting Trademark of the DVB - Digital Video Broadcasting Project.

The **TV EXPLORER HD DTMB** has an **HDMI** connector (High-Definition Multimedia Interface) which allows the use of standard, enhanced or high definition video, as well as 8 audio digital channels without compression. With no doubt, it will become the digital replacement for analogue standards such as the Euroconnector (SCART).

The **TV EXPLORER HD DTMB** also has a **DVB-ASI** standard interface, which allows both the input and output of transport streams. Automatically detects whether the stream is composed by 188 or 204 bytes, and can transmit data in packet mode or burst mode. You can select the input you want to decode between the external **ASI** and the internal demodulator, and what data you want in the **ASI** output, either from the demodulator or the **CAM** module. Therefore, to have **TS-ASI** inputs and outputs becomes an essential feature for a TV analyser ready for the future.

When pressing the **auto identification** key, it searches and identifies the **signal under test**. First it recognises whether the signal is an analogue channel or a digital one. If the channel is analogue, it determines the television standard of the signal. When the signal is digital (**DVB**), it analyses for each modulation type **QAM / QPSK / 8PSK / DTMB** all the associated parameters such as the modulation system: **symbol rate, code rate**, etc. and determines the value of the signals under test.

The range of frequencies covered makes this instrument an excellent tool for **FM radio, terrestrial TV, mobile TV, satellite TV** and **cable TV** (where the sub band tuning margin, from 5 to 45 MHz, enables the user to carry out tests on the return channel).

The **TV EXPLORER HD DTMB** includes the main **TV standards: M, N, B, G, I, D, K** and **L**, adopting, apart from the characteristic parameters of the standard, the correcting automatic system to obtain in all the cases an accurate measuring of the input signal level. It accepts any TV system (**PAL, SECAM** and **NTSC**) and allows the user to work directly with **digital TV** signals decoding them, so that the television image may be viewed, and directly measuring the power, carrier/noise ratio (**C/N**), the bit error rate (**BER**) and the modulation error ratio (**MER**), as well for **DTMB** as **DVB-S/S2 (QPSK/8PSK)** and **DVB-C (QAM)** signals. This instrument allows to obtain a graphical representation of the **Constellation Diagram** for **DVB-C (QAM), DTMB** and **DVB-S/S2 (QPSK/8PSK)** signals.

Being a multistandard instrument, it can be efficiently used in any country of the world.

Includes a **symbol-based keyboard** that allows the direct access to the various functions that are displayed simultaneously on screen.

The **TV EXPLORER HD DTMB** makes a **dynamic exploration** of the spectrum, detecting all the channels in the explored band, this applies for the **terrestrial** and the **satellite** television bands. The meter **locates** all the channels in the spectrum **with no need** of any **previous information** about the number of channels, the type of signals transmitted or their characteristics. With the data collected after each exploration, it creates a register that contains **tables of channels** that can be independent for each **system or installation**. At any time, the measurement sessions using only the pretuned channels can be repeated. In this way it is possible to optimise the measurement process.

Shown on the frontal panel is the **type of measurement** that is being carried (Terrestrial-Satellite/Analogue-Digital) and the data are presented on a hi-res 6.5" colour graphic **TFT** transfective display with panoramic aspect ratio (16:9). The equipment incorporates a light sensor that activates the contrast and luminosity of the display according to the environmental conditions.

Furthermore the **TV EXPLORER HD DTMB** comes with a connector for **CAM** modules (PC-Card) that allows the insertion of subscriber conditional access cards.

The **TV EXPLORER HD DTMB** is an **ideal size** to hold **with a hand**. The instrument can be held to the body with the carrying bag or transport belt, which at the same time protects it from the rain. Because it is designed for outdoor use, it includes an **anti-shock** protector that completely covers the instrument, and is supplied with a strong transport case. As well, the front panel does not have any keys nor gaps to avoid accidental water ingress.

The **TV EXPLORER HD DTMB** is designed to integrate measurements that require different operating configurations. In this way it incorporates a specific function to facilitate the **alignment of antennas**. When activating the alignment function the instrument is set automatically to offer a **fast spectrum sweep** and a high **sensitivity** graphical bar that allows **fine adjust** for the maximum signal. In addition it includes a module for the **powering of LNBS** and **DTMB antennas** to 5V, and the commands for the **programming of DiSEqC 1.2** and **SatCR devices**.

The **TV EXPLORER HD DTMB** can be updated to new software versions that extend the available functions in the future. That means it can incorporate new benefits without additional cost. For example, in the **test of satellite signals distribution networks**, using combined with an **IF** generator permits to carry out an easy verification of the installations before commissioning.

The **spectrum analyser** features with high accuracy, resolution, sensitivity and sweep speed allows the instrument to be very useful for applications as the **installation of antennas**. It presents an innovative control system based on four arrows, that makes the use of the spectrum analyser very intuitive. The arrows allow adjusting the **reference level** by steps of 10 or 5 dB and the frequency margin **span** on screen.

To enhance its convenience of use, it includes **memories** to store automatically the different data acquisitions, i.e.: acquisition name, test points, frequency, channel plan, etc. Moreover, the **DATALOGGER** function makes it much easier to test systems in which a large number of measurements have to be made, and enables further processing of all the information acquired using a computer system. The equipment is able to generate automatic measurement reports and to update itself through Internet by means of **PkTools** provided software.

The **TV EXPLORER HD ATSC** in addition, allows to record and play one service from the **TS** of the digital channel that is being demodulated by an internal memory up to 1 GB.

Also, this meter incorporates a **DiSEqC²** command generator and permits to supply different voltages to the external unit (**5 V / 13 V / 15 V / 18 V / 24 V**) and includes an **EUROCONNECTOR**, or Scart connector, for audio/video input/output.

The **TV EXPLORER HD DTMB** is powered by **rechargeable battery** or connected to the mains through the supplied **external DC power charger**.

It incorporates a "**USB On-the-go**" port, which enables the communication with a PC and to download dataloggers and channel plans.

This instrument due to its extreme-compact design, technical specifications and low cost becomes the industry standard for the installer.

1.2 Specifications

CONFIGURATION FOR MEASURING LEVEL AND POWER

TUNING	Digital frequency synthesis. Continuous tuning from 5 to 1000 MHz and from 950 to 2150 MHz. (Terrestrial and Satellital respectively).
Tuning modes	Channel or frequency (IF or downlink at satellite band). Channel plan configurable on demand.
Resolution	5-1000 MHz: 50 kHz. 950-2150 MHz: < 200 kHz (span FULL-500-200-100-50-32-16 MHz).
Automatic search (<i>Explorer</i>)	Threshold level selectable. DTMB, DVB-C, DVB-S and DVB-S2 selection.

² *DiSEqCTM* is a trademark of EUTELSAT.

Signal identification	Analogue and digital. Automatic.
RF INPUT	
Impedance	75 Ω .
Connector	Universal, with BNC or F adapter.
Maximum signal	130 dB μ V.
Maximum input voltage	
DC to 100 Hz	50 Vrms (powered by the AL-103 power charger). 30 Vrms (not powered by the AL-103 power charger).
5 MHz to 2150 MHz	130 dB μ V.
DIGITAL SIGNALS MEASUREMENT	
MARGIN OF POWER MEASUREMENT	
DTMB:	45 dB μ V to 100 dB μ V.
QAM:	45 dB μ V to 110 dB μ V.
QPSK/8PSK:	44 dB μ V to 114 dB μ V.
MEASUREMENTS	
DTMB	Power, MER, C/N, LBER, LDPC Iterations and Link Margin.
Presentation	Numeric and level bar.
DVB-C (QAM):	Power, BER, MER, C/N and Noise margin.
Presentation:	Numeric and level bar.
DVB-S (QPSK):	Power, CBER, VBER, MER, C/N and Noise margin.
Presentation:	Numeric and level bar.
DVB-S2 (QPSK/8PSK):	Power, CBER, LBER, MER, C/N, wrong packets and Link Margin.
Presentation:	Numeric and level bar.
CONSTELLATION DIAGRAM	
Type of signal	DTMB, DVB-C, DVB-S and DVB-S2.
Presentation	I-Q graph.
DTMB SIGNAL PARAMETERS	
Carriers	Multi Carrier or Single Carrier.
Guard Interval	420, 595, 945.
Code Rate	0.40, 0.60, 0.80.
Modulation	4QAM, 4QAM-NR, 16QAM, 32QAM, 64QAM.
Bandwidth	8 MHz.
Time interleaver	240, 720.
DVB-C SIGNAL PARAMETERS	
Demodulation	16/32/64/128/256 QAM.
Symbol rate	1000 to 7000 kbauds.
Roll-off (α) factor of Nyquist filter	0.15.
Spectral inversion	Selectable: ON, OFF.

DVB-S SIGNAL PARAMETERS

Symbol rate	2 to 45 Mbauds.
Roll-off (α) factor of Nyquist filter	0.35.
Code Rate	1/2, 2/3, 3/4, 5/6, 7/8 and AUTO.
Spectral inversion	Selectable: ON, OFF.

DVB-S2 SIGNAL PARAMETERS

Symbol rate (QPSK)	1 to 45 MSps.
Symbol rate (8PSK)	1 to 45 MSps.
Roll-off (α) factor of Nyquist filter	0.20, 0.25 and 0.35.
Code Rate (QPSK)	1/4, 1/3, 2/5, 1/2, 3/5, 2/3, 3/4, 4/5, 5/6, 8/9, 9/10 and AUTO.
Code Rate (8PSK)	3/5, 2/3, 3/4, 5/6, 8/9, 9/10 and AUTO.
Spectral inversion	Selectable: ON, OFF.
Pilots	Indication if are present.

STANDART VIDEO

Format	DVB: MPEG-2 (MP@HL) (Main Profile High Level). MPEG-4 AVC H.264 (free or scrambled) (High Profile Level 4.1)
---------------	---

Services decoding	Service list and PIDs.
--------------------------	------------------------

HD VIDEO

Input resolution	1080i, 720p and 576i.
Aspect Ratio	16:9 and 4:3.
HDMI Output Resolution	1920 x 1080.
Audio	MPEG-1, MPEG-2, HE-AAC, Dolby Digital and Dolby Digital Plus.
Compression type	MPEG-2 y MPEG-4 H.264.

ANALOGUE SIGNALS MEASUREMENT**LEVEL MEASUREMENT****Measurement range**

Terrestrial TV & FM bands	10 dB μ V to 130 dB μ V (3.16 μ V to 3,16 V).
Satellite TV band	30 dB μ V to 130 dB μ V (31.6 μ V to 3,16 V).
Reading	Auto-range, reading is displayed on an OSD window.

Digital	Absolute value calibrated in dB μ V, dBmV or dBm.
Analogue	Relative value through an analogue bar on the screen.

Measurement bandwidth	230 kHz (Terrestrial band) ■ 4 MHz (Satellite band) According to span (maximum band ripple 1 dB).
------------------------------	--

Audible indicator	LV audio. A tone with pitch proportional to signal strength.
--------------------------	--

Accuracy	
Subband	±1,5 dB (30-120 dBμV, 5-45 MHz) (22 °C±5 °C).
Terrestrial bands	±1.5 dB (30-120 dBμV, 45-1000 MHz) (22 °C±5 °C).
Satellite band	±2.5 dB (40-100 dBμV, 950-2050 MHz) (22 °C ± 5 °C).
Over range indication	< >.
MEASUREMENTS MODE	
Terrestrial bands	
Analogue channels	Level, Video-Audio ratio, Carrier-Noise ratio and frequency deviation.
Digital channels	Channel power, Carrier-Noise ratio and Channel identification.
Satellite band	
Analogue channels	Level and Carrier-Noise ratio.
Digital channels	Channel power and Carrier-Noise ratio.
DATALOGGER function³	
Analogue channels	Measurements automatic acquisition and storage. Level, C/N and V/A ratios.
Digital channels	Frequency offset, MPEG-2 / MPEG-4 detection, power, C/N, MER, CBER, VBER, LBER and noise margin.
SAT IF TEST Function⁴	IF distribution network response for satellite band.
ATTENUATION TEST Function⁵	Signal distribution network response for terrestrial band.
SPECTRUM ANALYSER MODE	
Satellite band	30 dBμV to 130 dBμV (31.6 μV to 3.16 V).
Terrestrial bands	10 dBμV to 130 dBμV (3.16 μV to 3.16 V).
Measurement bandwidth	According to span.
Terrestrial	230 kHz, 1 MHz.
Satellite	4 MHz, 1 MHz.
Span	
Terrestrial	<i>Full span</i> (full band) - 500 - 200 - 100 - 50 - 32 - 16 - 8 MHz selectable.
Satellite	<i>Full span</i> (full band) - 500 - 200 - 100 - 50 - 32 - 16 MHz selectable.
Markers	1 with Frequency and level or C/N indications.
Vertical range	Adjustable in steps of 5 or 10 dB.
Measurements	
Terrestrial bands	
Analogue channels	Level.
Digital channels	Channel power.

³ Using PkTools software application with a PC.

⁴ Function to be used with RP-250 or RP-050 IF signal simulator.

⁵ Function to be used with RP-250 or RP-080 pilot signals simulator.

Satellite band	
Analogue channels	Level.
Digital channels	Channel power.
ECHOES ANALYSER MODE (DTMB)	
Measurement range	
Delay	0.1 μ s to 200 μ s.
Distance	0.3 km to 60 km.
Power range	0 dBc to -30 dBc.
MONITOR DISPLAY	
Monitor	TFT colour 6.5 inches. Transflective LCD.
Aspect ratio	16:9, 4:3.
Colour system	PAL, SECAM and NTSC.
TV standard	M, N, B, G, I, D, K and L.
Spectrum mode	Variable span, dynamic range and reference level by means of arrow cursors.
Sensibility	40 dB μ V for correct synchronism.
BASE BAND SIGNAL	
VIDEO	
Format	DVB: MPEG-2 (MP@HL). MPEG-4 AVC H.264 (free or scrambled). <i>Common Interface</i> , according to available user CAM.
Conditional access types	
External video input	Scart.
Sensibility	1 Vpp (75 Ω) positive video.
Video output	Scart (75 Ω).
SOUND	
Input	Scart.
Outputs	Built in speaker, Scart.
Demodulation	TV PAL, SECAM, NTSC system according to DTMB, DVB-C, DVB-S/S2 and MPEG standards.
De-emphasis	50 μ s, 75 μ s (NTSC).
Subcarrier	Digital frequency synthesis according to the TV standard.
USB INTERFACE	
	"USB On-the-go" for datalogger and channel plans transfer.
	<ul style="list-style-type: none">- Mass Storage Host: The equipment can read / write on Flash drives.- Serial Port Emulation.- USB CDC: (Communications Device Class).
DVB-ASI INTERFACE	
Type	1 DVB-ASI input and 1 DVB-ASI output.
Connectors	Female BNC, impedance 75 Ω .
Packets	Transport Stream of 188 or 204 bytes (automatic detection).

Transmission	Packet or burst mode ⁶ .
EXTERNAL UNITS POWER SUPPLY	
Terrestrial and Satellite	Through the RF input connector.
22 kHz signal	External or 5/13/15/18/24 V.
Voltage	Selectable in satellite band.
Frequency	0.65 V ± 0.25 V.
Maximum power⁶	22 kHz ± 4 kHz.
	5 W.
DiSEqC⁷ GENERATOR	According to DiSEqC 1.2 standard.
POWER SUPPLY	
Internal	
Batteries	7.2 V 12 Ah Li-Ion battery.
Autonomy	> 4.5 hours in continuous mode.
Recharging time	3 hours up to 80% (instrument off).
External	
Voltage	12 V.
Consumption	40 W.
Auto power off	Programmable. After the selected amount of minutes without operating on any control. Deactivable.
OPERATING ENVIRONMENTAL CONDITIONS	
Altitude	Up to 2000 m.
Temperature range	From 5 to 40 °C (Automatic disconnection by excess of temperature).
Max. relative humidity	80 % (up to 31°C), decreasing lineally up to 50% at 40 °C.
MECHANICAL FEATURES	
Dimensions	230 (W) x 161 (H) x 76 (D) mm. (Total size: 2.814 cm ³).
Weight	2.2 kg (without holster).
INCLUDED ACCESSORIES.	
1x CB-077	Rechargeable Li+ battery 7,2 V 12 Ah.
1x AT-010	10 dB attenuator.
1x AD-055	"F"/F-BNC/F adapter.
1x AD-056	"F"/F-"DIN"/F adapter.
1x AD-057	"F"/F-"F"/F adapter.
1x AL-103	External DC charger.
1x DC-229	Transport suitcase.
1x DC-267	Carrying bag.

⁶ If you select 5V, the maximum power shall not exceed 2.25 W (450 mA).

⁷ DiSEqCTM is a trademark of EUTELSAT

1x DC-289	Transport belt.
1x AA-103	Car lighter charger.
1x CC-041	Connection USB Cable On-the-go (A) Male – Mini USB (B) Male.
1x CC-045	USB Cable (A) Female – Mini USB (A) Male.
1x CA-005	Mains cord.
1x	USB Memory.

RECOMMENDATIONS ABOUT THE PACKING















It is recommended to keep all the packing material in order to return the equipment, if necessary, to the Technical Service.

2 SAFETY RULES

2.1 General safety rules

- * **The safety could not be assured if the instructions for use are not closely followed.**
- * Use this equipment connected **only to systems with their negative of measurement connected to ground potential.**
- * The **AL-103** external DC charger is a **Class I** equipment, for safety reasons plug it to a supply line with the corresponding **ground terminal**.
- * This equipment can be used in **Overvoltage Category I** installations and **Pollution Degree 2** environments.
External DC charger can be used in **Overvoltage Category II**, installation and **Pollution Degree 1** environments.
- * When using some of the following accessories **use only the specified ones** to ensure safety.
 - Rechargeable battery
 - External DC charger
 - Car lighter charger cable
 - Power cord
- * Observe all **specified ratings** both of supply and measurement.
- * Remember that voltages higher than **70 V DC** or **33 V AC rms** are dangerous.
- * Use this instrument under the **specified environmental conditions**.
- * When using the power adaptor, the **negative of measurement** is at ground potential.
- * **Do not obstruct the ventilation system** of the instrument.
- * Use for the signal inputs/outputs, specially when working with high levels, appropriate low radiation cables.
- * Follow the **cleaning instructions** described in the Maintenance paragraph.

* Symbols related with safety:

	DIRECT CURRENT		ON (Supply)
	ALTERNATING CURRENT		OFF (Supply)
	DIRECT AND ALTERNATING		DOUBLE INSULATION (Class II protection)
	GROUND TERMINAL		CAUTION (Risk of electric shock)
	PROTECTIVE CONDUCTOR		CAUTION REFER TO MANUAL
	FRAME TERMINAL		FUSE
	EQUIPOTENTIALITY		EQUIPMENT OR COMPONENT TO BE RECYCLED

2.2 Descriptive Examples of Over-Voltage Categories

Cat I Low voltage installations isolated from the mains.

Cat II Portable domestic installations.

Cat III Fixed domestic installations.

Cat IV Industrial installations.

3 INSTALLATION

3.1 Power Supply

The **TV EXPLORER HD DTMB** is a portable instrument powered by one 7.2 V Li-Ion battery. There is also an external DC charger provided for mains connection and battery charging.

3.1.1 Operation using the External DC Charger

Connect the external DC charger to **EXT. SUPPLY** [32] on the **TV EXPLORER HD DTMB** side panel. Connect the DC charger to the mains. Then, press the rotary selector  [1] for more than two seconds. The level meter is now in operation and the battery is slowly charged. When the instrument is connected to the mains, the **CHARGER** indicator [4] remains lit. This indicator changes of colour according to the battery charge status:

BATTERY CHARGE STATUS		
	OFF	ON
RED	< 50 %	< 90 %
ORANGE	> 50 %	> 90 %
GREEN	100 %	100 %

Table 1.- Indication of the battery charge status (**CHARGER**).

3.1.2 Operation using the Battery

For the device to operate on the battery, disconnect the power cable and press the rotary selector  [1] for more than two seconds. The fully charged battery can power the equipment for more than 4.5 hours non-stop.

If battery is very weak, the battery cut-off circuit will prevent the device from functioning. In such a situation battery must be recharged immediately.

Before taking any measurements, you have to check the charge status of the battery by checking the battery charge level indicator that appears when activating the

measurement mode pressing key  [12]. These are the indicators on screen:







BATTERY CHARGE LEVEL INDICATORS		
COLOUR	SYMBOL	CHARGE LEVEL
GREEN		75 % ~ 100 %
GREEN		30 % ~ 75 %
GREEN		10 % ~ 30 %
RED		0 % ~ 10 %
		Empty battery.
		Recharge in progress.

Table 2.- Indication of the battery charge level on screen.

3.1.2.1 Battery Charging

To fully charge the battery, connect the instrument to the external DC charger **without activating** the power on process. The length of time it takes to recharge it depends on the condition of the battery. When the instrument is in operation the recharging process is slower. If they are very low the recharging period is about 5 hours. The **CHARGER** [4] indicator should remain lit.



When the battery charging process is completed with the instrument off, the fan stops.

IMPORTANT

The instrument battery needs to be kept charged between 30% and 50% of its capacity when not in use. The battery needs to be fully charged for best results. A fully charged battery suffers temperature-related discharge. For example, at a room temperature of 20 °C, it can lose up to 10% of its charge over 12 months.

3.2 Installation and Start-up

The **TV EXPLORER HD** DTMB level meter is designed for use as a portable device. Therefore does not require installation

When the rotary selector  [1] is pressed for more than two seconds, the instrument is started up in the *automatic power-off* mode; that is, the device is automatically disconnected after the selected minutes if no key has been pressed. When the device is operating, it is also possible to select the **auto power-off** mode by means of the **Preferences** menu  [22] and to select the time out until the automatic power-off.

When the equipment is going to be moved, activate the **Transport** mode by means of the **Preferences** menu  [22] to disable the power on process until one specific key from main keyboard is pressed [8] as is it indicated on screen.

4 QUICK USER GUIDE

STEP 1.- Battery charging

1. Connect the DC external charger to the equipment through connector [32] located on the lateral panel.
2. Connect the DC charger to the mains.
3. When the equipment is connected to the mains, the **CHARGER** led [4] remains lighted.

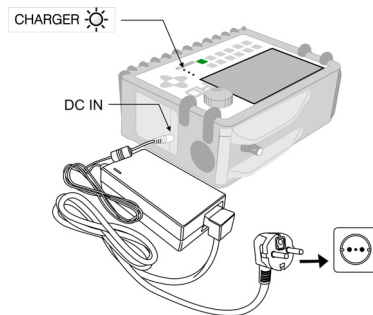



Figure 1.- Battery charging

STEP 2.- Power on and signal connection

1. Hold the rotary selector  [1] pressed until the equipment is powered on.
2. Connect the **RF** signal source in the input connector [30].

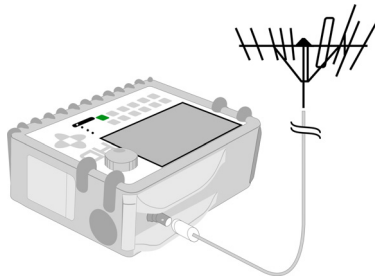









Figure 2.- Power on and signal connection.

STEP 3.- To carry out a complete channel band exploration

1. Select the frequency band to explore  [14] (terrestrial or satellite).
2. Activate the exploration process by holding  [25] key pressed.
3. Press  [10] key to visualise the channels detected and  [6] to change between channels from detected channels list.



STEP 4.- To carry out the tuned channel identification

1. Select the frequency band to explore  [14] (terrestrial or satellite).
2. Activate the identification process pressing once on  [25] key.
3. Press  [10] key to visualise the signal detected from channel or frequency identified or  [13] to monitor the corresponding spectrum.





NOTE: In the case that is desired to explore or identify **DVB-C** signals it is necessary to select previously **DVB-C** standard as digital signal identifier

through  [22] **PREFERENCES** menu.







STEP 5.- Making measurements

1. Select the channel or frequency  [24] to measure by means of the rotary selector  [1].
2. Press  [12] key to select the type of measurement until on screen appears the corresponding measurement.

STEP 6.- Frequency spectrum monitoring

1. Select the frequency band  to graph [14] (terrestrial or satellite).
2. Press  [13] key to activate the signal sweeping.
3. Press  [6] to modify the reference level in the vertical axis.
4. Press  [6] to modify span in the horizontal axis.

STEP 7.- Video signal monitoring

1. Select the terrestrial frequency band  [14].
2. Tune the channel or frequency  [24] that is desired to visualize on screen.
3. Verify that the equipment receives an appropriate signal level  [12].
4. Press  [10] key to visualise the TV image, if the channel is digital press  [6] and place the cursor on the Service Identifier field and press the rotary selector  [1] to obtain the available list of services.



5 OPERATING INSTRUCTIONS

WARNING:

The following described functions could be modified based on software updates of the equipment, carried out after manufacturing and the publication of this manual.

5.1 Description of the Controls and Elements

Front panel

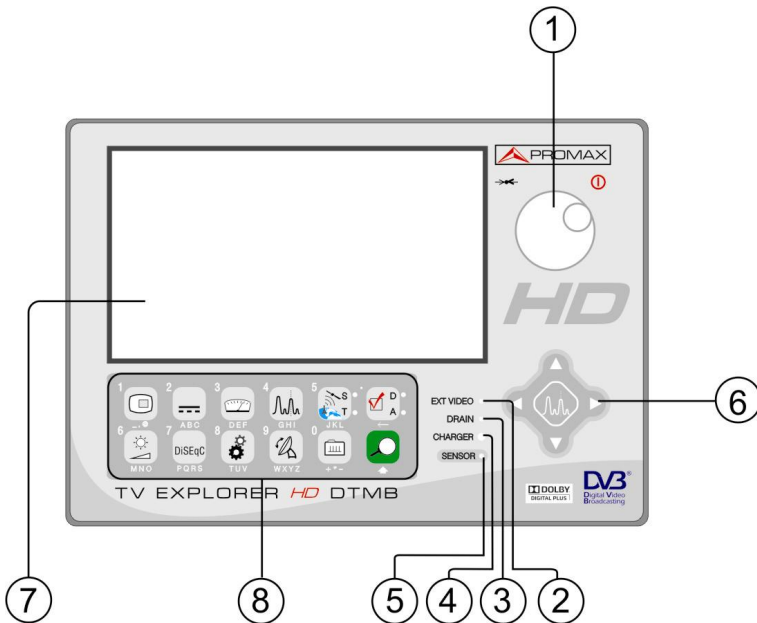

Figure 3.- Front panel.

- [1] **Rotary selector - button.** This has many different functions: Equipment power on/off, tuning control, moving between the various on-screen menus and sub-menus, and validation of the different options.

In order to **power on** the equipment, hold the rotary selector pressed for more than two seconds until the presentation screen appears.

In order to **power off** the meter hold the rotary selector pressed.

Tuning purposes: turning it clockwise frequency increases while turning it anticlockwise frequency decreases.

To **move along the on-screen menus:** turning it clockwise active option moves downwards while turning it anticlockwise active option moves upwards.

[2] **EXT VIDEO. Video signal presence light indicator**

It lights up when video on screen is coming through the **SCART** connector [35].

[3] **DRAIN**

External units power supply indicator. Lights up when the **TV EXPLORER HD DTMB** supplies a current to the external unit.

[4] **CHARGER**

External DC charger operation indicator. When batteries are installed the battery charger is automatically activated.

[5] **SENSOR**

Sensor of environmental luminosity, allows automatic adjusts of the display contrast and brightness contributing to the battery saving.



[6] **CURSORS**

Allow adjust in the Spectrum Analyser mode of the **reference level** and the margin of frequencies to represent (**span**). As well as the movement through the different menus and submenus that appear in the monitor.

[7] **MONITOR**

[8] **MAIN KEYBOARD**

12 keys to select functions and entering alphanumeric data.

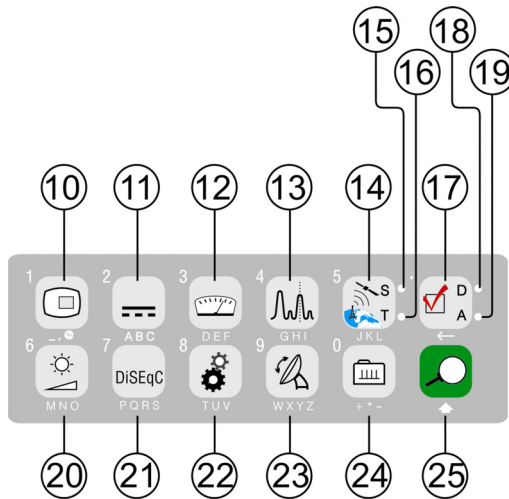



Figure 4.- Main keyboard

- 1







[10] TV KEY
It allows visualising the image of TV corresponding to the input signal as well as data relative to the reception of the video signal.
Key number 1 to enter numeric data.
- 2



[11] EXTERNAL UNITS POWER SUPPLY
Enables selecting the power supply to the external units. Available voltages are: **External, 5 V, 13 V, 15 V, 18 V and 24 V** for the terrestrial band and **External, 5 V, 13 V, 15 V, 18 V, 13 V + 22 kHz and 18 V + 22 kHz** for the satellite band.
Key number 2 to enter numeric data.
- 3



[12] MEASUREMENTS
Enables the type of measurement to be selected. The types of measurements available depend on the band, the standard and the operating mode.
Key number 3 to enter numeric data.

- [13]  **SPECTRUM/TV**
Allows switching between any previous operating mode and the Spectrum Analyser mode and vice versa.
Key number 4 to enter numeric data.
- [14]  **SATELLITE/TERRESTRIAL BAND**
Allows switching between the Satellite or Terrestrial TV frequency band.
Key number 5 to enter numeric data.
- [15] **S**
This led remains lighted when the equipment works with the frequencies and the corresponding channels to the satellite band.
- [16] **T**
This led remains lighted when the equipment works with the frequencies and the corresponding channels to the terrestrial band.
- [17]  **MEASUREMENT CONFIGURATION**
It allows the commutation between the measurement mode for Digital TV or Analogue TV.
- [18] **D**
This led remains lighted when the equipment works with digital signals.
- [19] **A**
This led remains lighted when the equipment works with analogue signals.
- [20]  **IMAGE ADJUST**
Activation of **VOLUME, CONTRAST, BRIGHT, SATURATION** and **HUE** (only for NTSC colour system) control menus.
Key number 6 to enter numeric data.
- [21]  **DISEQC**
(Only in satellite band). It allows adjusting configuration parameters in satellite band.
Key number 7 to enter numeric data.

8



[22] UTILITIES / PREFERENCES

It activates the **Utilities** menu (short pulsation):

- Equipment Info.** Displays information about the instrument: Company's Name; Instrument's Name; Product Number; Control Software Version; User, that shows free disk space (compact flash) to store data (Datalogger and channel plans); Video, that shows free disk space to save Transport Streams; Date and time.

- Constellation** Sets the constellation diagram graph for the digital signal on tune.

- Attenuation Test** (Only terrestrial band).
Selects the function for testing signal distribution networks in terrestrial band.

- Sat IF Test** (Only satellite band).
Selects the function for testing signal distribution networks in satellite band.

- DTMB Echoes** Graphical representation of the channel response and list of echoes detected in the signal response.

- PVR** It saves or plays a video stream.

- Run Datalogger** Function to automatically acquire measurements.

- View Datalogger** Displays the available acquisition list.
- Erase Dataloggers** Deletes an acquisition previously recorded.
- Delete Channel Set** Delete the channel plan selected.
- Delete Channels** Delete a channel from the active channel plan.
- Insert Channels** Add a channel to the current channel plan from another standard list of channels.

- Save as:** Saves with a file name the capture screen in order to be later processed.

- Recall Constell** Recall a constellation diagram stored in memory.
- Recall Spectrogram** Recall a Spectrogram graph stored in memory.
- Recall Spectrum** Recall a signal spectrum previously stored.

Delete Capture	Allows to delete a screen capture file.
Delete Print Screen	It allows deleting a selected print screen.
Exit	Exit from Utilities.
It activates the Preferences menu (long pulsation):	
Language	Selects the language between DEUTSCH, ENGLISH, ESPAÑOL, FRANÇAIS, ITALIANO, CATALÀ and PORTUGUÊS.
Beep	Activates (ON) / deactivates (OFF) the beeper.
Skin	Sets the display skin. It is possible to add new types through the USB port.
Light Sensor	It activates a light sensor to automatically adjust the display contrast and brightness. Options are: High contrast (with high luminosity), Low contrast (with low luminosity) and AUTO.
Power measure	It allows you to select between two options to measure power: Integrated or extrapolated. The integrated method performs a calculation based on the true RMS value for any type of signal. The extrapolated method is an approximation according to power measurements already taken.
Ter. Identify	Selects the type of terrestrial digital signal, DTMB or DVB-C, used by AUTO-ID and EXPLORER functions.
Min. Ter. Power	Sets the minimum power for a terrestrial digital signal to be identified.
Min. Ter. Level	Sets the minimum level for a terrestrial analogue signal to be identified.
QAM-A Identify	When using automatic identification for DVB-C signal, it should be also selected its annex. To work with Annex-A put this option to YES. To work with Annex-B put this option to NO.
Min. Sat. Power	Sets the minimum power for a satellite digital signal to be identified.
C/N	Defines the C/N measuring method between <i>Auto</i> or <i>Reference Noise (Manual)</i> , used to determine the frequency where noise level will be measured in the spectrum analyser mode.

- Identify Timeout** Sets the maximum time that the equipment will carry out the identification of a channel unknown before going to the next one.

- Sat Band** (Only satellite band).
Selects the C-band or Ku-band for tuning satellite signals.

- Auto Power Off** Activates the automatic power off mode.

- Time Power Off** Select the power off timeout from 1 to 120 minutes.

- Terrestrial Units** Select the measurements units for terrestrial and cable: dB μ V, dBmV or dBm.

- Satellite Units** Select the measurements units for satellite: dB μ V, dBmV or dBm.

- Rotary Selector** Select the movement sense: CW (clockwise) or CCW (counter clockwise).

- Ref. level** It selects the most suitable range when accessing to the spectrum analyser mode: MANUAL (defined by the user) or AUTO (calculated by the instrument).

- Transport Mode** It activates or it deactivates the automatic power off function for transportation. So, it allows to prevent an accidental start-up of the equipment.

- Factory Reset** It recovers the default settings (the ones the equipment originally had). This option will remove all acquisitions made by the user. Added channel plans are kept.

- Exit** Exit from preferences menu.

Key number 8 to enter numeric data.



[23] ANTENNA ALIGNMENT

Tool for faster sweep antenna alignment at terrestrial and satellite bands. Displays the measurements by means of a graph level bar.
Key number 9 to enter numeric data.



[24] TUNING BY CHANNEL OR FREQUENCY

Switches tuning mode between channel and frequency. In channel mode the tuning frequency is defined by the active channels table (CCIR, ...).
Key number 0 to enter numeric data.



[25] **AUTO ID/ EXPLORER**

Activates the **automatic identification** function (short pulsation):

The instrument will try to identify the signal under test.

First it recognises whether the signal is an analogue channel or a digital one.

If the channel is analogue, it determines the television standard of the signal detected.

When the signal is digital, it analyses the modulation type: **DTMB / DVB-C / DVB-S / DVB-S2** and all the associated; parameters such as the **carriers 2k-8k**, the **symbol rate**, the **code rate**, etc and it tries to lock to the signal.

In the spectrum analyser and measurements mode, it appears on screen the name of the **network** and the **orbital position** (only in satellite band).

Activates the band **exploration** function (long pulsation):

The meter explores the entire frequency band to identify the analogue and digital channels present.

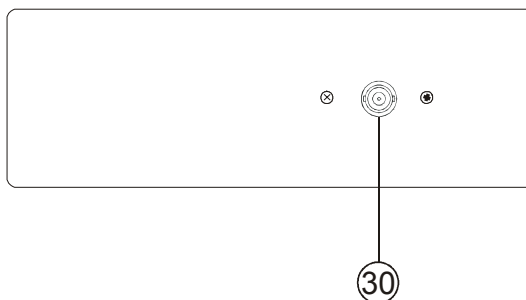



Figure 5.- Top panel view.

[30] RF  RF signal input

Maximum level 130 dB μ V. Universal connector for F/F or F/BNC adapter, with input impedance of 75 Ω .

ATTENTION 

Use the 10 dB attenuator (AT-010) to protect the RF  [30] input whenever the input signal level is greater than 130 dB μ V (1 V) or when suspecting about intermodulation problems.

This accessory allows DC voltages to pass when powering external units as LNB and amplifiers.

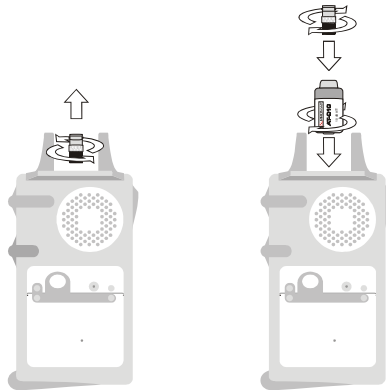



Figure 6.- Connecting external attenuator on RF input [30].

ATTENTION 

Note the importance to protect the RF  [30] input signal with an accessory to block the AC voltages used in CATV cables (needed to feed the amplifiers) and remote control.

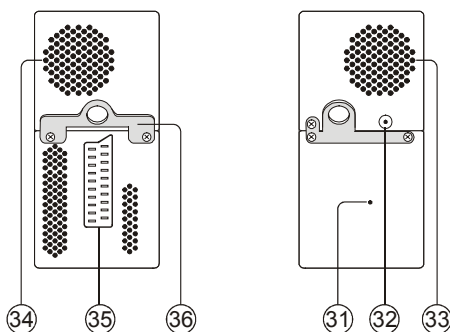

Figure 7.- Lateral panel elements.

[31] RESET button

Enables the user to restart the instrument if there is any irregularity when operating.

[32] External 12 V power supply input

[33] Loudspeaker

[34] Fan

[35] SCART connector

[36] Transport belt hook

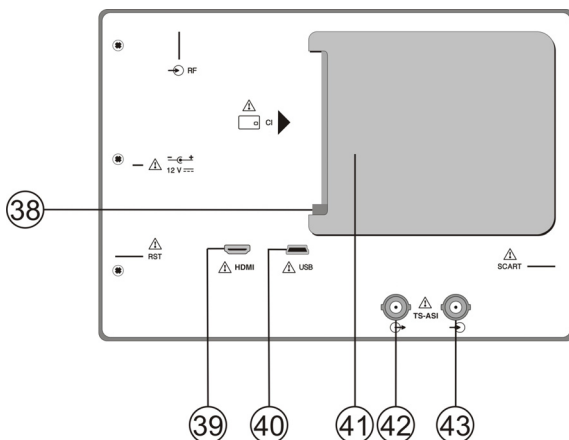

Figure 8.- Rear panel view.

[38] CAM module extraction button

Press it to remove a **CAM** module inserted into the connection socket [38].

[39] HDMI Connector (High-Definition Multi-media Interface).**[40] USB Connector**



It enables the communication with a PC, and to download dataloggers and channel plans.

[41] CAM module connection socket



Enables the conditional access (desencryption) of encoded digital TV signals in agreement with **DVB-CI** (*Common Interface*) recommendation.

[42] TS-ASI Output.**[43] TS-ASI Input.**

5.2 Adjustment of Volume and Monitor Parameters

Repeatedly pressing the  [20] key sequentially activates the **VOLUME**, **CONTRAST**, **BRIGHTNESS**, **SATURATION** and **HUE** control menus (this last only for NTSC colour system). On activation of a menu for a specific parameter the screen displays a horizontal bar whose length is proportional to the parameter level, to modify this value simply turn the rotary selector  [1]. To exit the menu and validate the new value press the rotary selector  [1].

5.3 Selecting the Operation Mode: TV / Spectrum Analyser / Measurements

The **TV EXPLORER HD DTMB** has three basic operation modes: **TV**, **Spectrum Analyser** and **Measurements**. To switch from TV operation mode to the Spectrum Analyser press  [13] key. To switch to the Measurements mode press  [12] key.

In the **TV operation** mode the demodulated television signal is shown on-screen; this is the default operation mode, various functions can be selected, as shown in the following paragraphs.

In the **Spectrum Analyser** operation mode the screen displays the spectrum of the active band (terrestrial or satellite). The *span* and the *reference level*.

In the **Measurement** mode the screen shows the available measurements according to the type of signal selected.

5.4 Channel Tuning / Frequency Tuning

Pressing  [24] key the **EXPLORER** switches from frequency tuning to channel tuning and back again.

In **channel tuning mode** turning the rotary selector  [1] sequentially tunes the channels defined in the active channels table. When turning it clockwise frequency increases while turning it anticlockwise frequency decreases.

In **frequency tuning mode** there are two ways of tuning:

1. Turning the rotary selector [1].

Turning the rotary selector  [1] selects the desired frequency (tuning is continuous from 5 to 1000 MHz and from 950 to 2150 MHz). When turning it clockwise frequency increases while turning it anticlockwise frequency decreases.

2. Using the keyboard.

Press the rotary selector  [1] (the frequency listing will disappear and will appear on the upper left corner of screen the keyboard symbol of manual data



entry  123), next enter the frequency value in MHz using the numeric keyboard. The **TV EXPLORER HD DTMB** will calculate the tuneable frequency closest to the entered value and then display it on-screen.

5.5 Automatic Transmission Search

Holding pressed the  [25] key search starts over the active channel plan. When tuning a channel the instrument tries to identify it and save it with the configuration. If the identification is not possible the channel is removed from list. As a result obtains a new channel plan that only contains the channels that have been identified.



5.6 Selecting the measurement configuration: Analogue/ Digital signal

Measuring the characteristics of a channel depends, in the first place, on the type of modulation: analogue or digital.

Use key  [17] to switch between analogue and digital channels. Press the  [17] key to show the **measurements CONFIGURATION** menu and select the **Signal** option by turning and pressing the rotary selector  [1]. The **Signal** option allows setting the type of signal to measure. When switching to a new type, the **TV EXPLORER HD DTMB** activates the last measurement configuration used for that type of signal.

5.7 External Units Power Supply

The **TV EXPLORER HD DTMB** can supply the voltage needed to power the external units (antenna preamplifiers, in the case of terrestrial TV, LNB in the case of satellite TV, or IF simulators).

In order to select the supply voltage of the external units, press  [11] key, and the screen will display a functions menu labelled **EXT. SUPPLY** listing the choice of voltages (which will depend on the band being used). Turn the rotary selector  [1] to the desired voltage and press to activate it. The following table shows the choice of supply voltages:

Band	Powering voltages
SATELLITE	Output: Enabled / Disabled External 5 V 13 V 15 V 18 V 24 V 13 V + 22 kHz 18 V + 22 kHz
TERRESTRIAL	Output: Enabled / Disabled External 5 V 13 V 15 V 18 V 24 V
MATV (Master Antenna Television)	24 V



Table 3.- External units powering voltages.

When the **OUTPUT** is enabled, the equipment puts at the output the voltage selected by the user. When the **OUTPUT** is disabled it does not apply the voltage at the output but it works like it was.

In the **External** power supply mode is the unit powering the amplifiers before the antenna (terrestrial television) or the satellite TV receiver (house-hold or community) also powers the external units.

The **DRAIN** [3] indicator lights when current is flowing to the external unit. If any kind of problem occurs (e.g., a short circuit), an error message appears on the monitor ('SUPPLY SHORT'), the acoustic indicator will be heard and the instrument will cease to supply power. The **TV EXPLORER HD DTMB** does not return to its normal operating state until the problem has been solved, during this time it verifies every three seconds the persistence of the problem warning with an acoustic signal.

5.8 Automatic signal identification function (AUTO ID)

The **TV EXPLORER HD DTMB** allows automatically identifying TV signals, according to the established configuration, which are presents in the channel or tuned frequency. In order to activate this function must once press  [25] key. Specially useful, is to combine this process with the spectrum monitoring  [13], so that after locating the marker on the levels susceptible to contain a transmission, and activating later the process of automatic identification in order to identify the present signal.

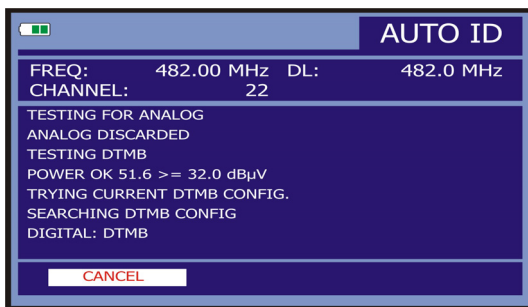



Figure 9.- Signal automatic identification screen. **AUTO ID**.

First it recognises whether the signal is an analogue channel or a digital one. If the channel is analogue, it determines the television standard of the signal. When the signal is digital (**DVB**), it analyses for each modulation type **QAM / QPSK / 8PSK / DTMB** all the associated parameters such as the modulation system: **carriers, symbol rate, code rate**, etc., and determines the value of the signals under test.

If the **AUTO ID** function is launched in the spectrum analyser mode, the name of the **network** will appear temporarily on screen (it also appears in the measurement display). In case of working in the satellite band the **orbital position** appears as well.

While performing automatic identification may be the equipment keeps detecting the **NETWORK ID** for a long time. During this process, the **CANCEL** button switches to **SKIP**, which allows by passing the **NETWORK ID** without losing the other parameters of the autodetection.

Whenever the process detects new parameters for a channel or frequency will create a new channel plan containing the detected information.

NOTE:  icon in the upper corner of a digital measurement screen states that the signal level is higher than the minimum threshold (see the **PREFERENCES** menu) but demodulator cannot lock it maybe due to some wrong configuration parameter.

In such case, the user must press **AUTO ID**  [25] key.

NOTE: In the case that is desired to explore or identify **DVB-C** signals will be necessary to select previously a **DVB-C** standard as digital signal identifier by means of  [22] **PREFERENCES** menu.

5.9 Channel plans

The signal automatic identification process as much as the exploration of the frequency spectrum could yield the generation of new customised channel plans relative to the usual work locations of the meter equipment.

In this way the characterisation of the band will be faster and easier when causing that the equipment only analyses a shorter set of channels.

Whenever a new process of exploration is activated, the **TV EXPLORER HD DTMB** analyses all the present channels in the active channel plan, which acts as pattern channel plan specified by means of the option **CHANNEL SET** from configuration measurement menu: **CONFIGURATION**  [17].

If during exploration or automatic identification process the **TV EXPLORER HD DTMB** detects new parameters for some channel or frequency a new list will be generated with the information updated and will be saved with the name of the original channel plan followed by the extension: **_0x**. (See the following Figure).

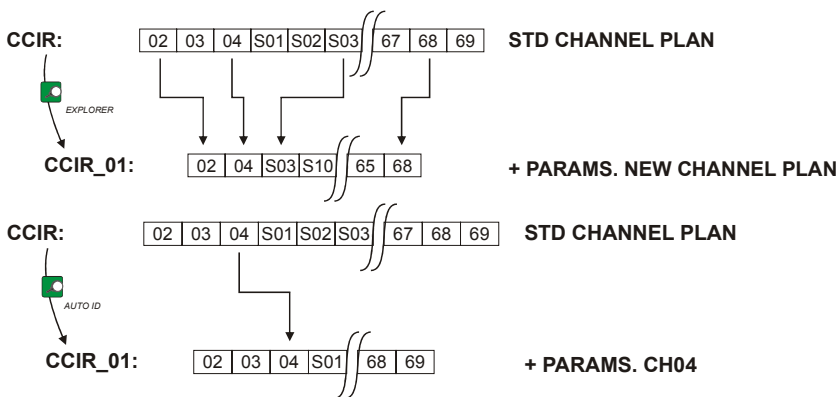

Figure 10.- New channel plan generation process.

Those channels that have not been identified during the exploration process are removed from the new generated channel plan. The user can save this table in the memory, modify its name and later use it by means of the **CONFIGURATION** [17] menu.

Also can delete any channel list, or remove and add channels from another standard list by means of the editing options offered by the **UTILITIES** [22] menu.

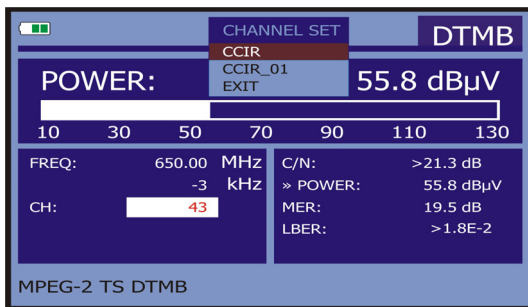







Figure 11.- Channel plans listing.

Keep the [24] key pressed in order to accede to the listing of channel plans available in the instrument and later select the current channel plan by means of the rotary selector [1].

The **TV EXPLORER HD DTMB** allows directly changing the tuned channel pertaining to the active channel plan by means of the horizontal cursors [6]  key. From this way, once selected the channel-tuning field  [24] and in the **TV**  [10] and **MEASUREMENTS**  [12] operation modes is possible to check cyclically the entire active channel list.

NOTE: The icon  in the upper corner of the screen indicates that the equipment is carrying out an internal operation and user must wait to complete it.

5.10 Acquisition function (DATALOGGER)

The **Datalogger** function allows the user to carry out and store measurements in a fully automatic way. It can store for each acquisition the measurements made in different points of the installation. The measurements made are relevant to the current analogue or digital channel, in the active channel plan.

To select the **Datalogger** function, activate the **UTILITIES**  [22] menu and select the **RUN DATALOGGER** option. Later, by turning the rotary selector [1] select a previously stored acquisition or a **NEW DATALOGGER**.

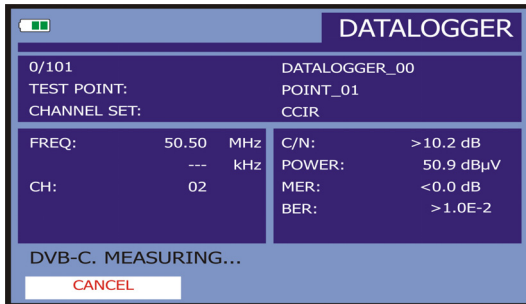





Figure 12.- DATALOGGER screen.

During analogue channel measuring process, a percentage counter appears at the bottom of the screen showing the percentage of channel measurement done. In the case of digital channels, appears a timer showing time left to finish in seconds. At the top left corner appears the channel being measured followed by the total amount of channels in the current channel plan.

In order to select the different fields on the screen, press the cursors  [6] key and then edit by pressing the rotary selector  [1].

After selecting the **START** field the instrument begins to carry out the available measurements automatically. Once completed, the process will be ready to repeat again (for example, for a new test point), or view measured data by turning the rotary selector  [1], or store the information in memory (**SAVE**) or exit from this acquisition (**EXIT**).

5.10.1 DATALOGGER for Attenuation and IF SAT tests

The **TV EXPLORER HD DTMB** allows to make measurement acquisitions while executing an Attenuation test at terrestrial band or an IF SAT test at satellite band (see section “5.11 Verification of distribution networks”).

For it, one of these tests should be activated previously as the following figure shows.

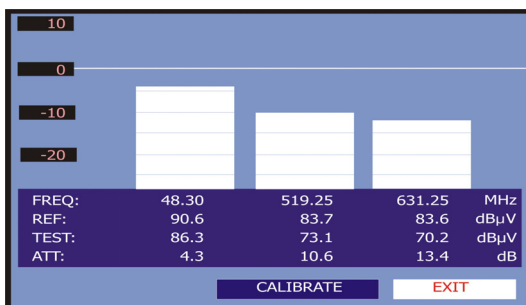



Figure 13.- Attenuation Test. Terrestrial band.

In order to make the automatic acquisition of these measurements, select it from  **UTILITIES** menu by pressing the  [22] key, and activating the **RUN DATALOGGER** option, and later the **NEW DATALOGGER** option. In the **CHANNEL SET** field will appear the type of test that the instrument is going to store automatically.

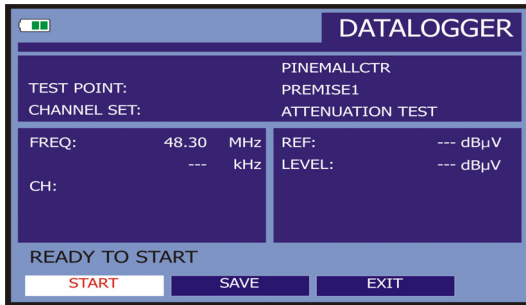

Figure 14.- Datalogger screen for Attenuation test frequencies.

Once the **START** option is selected the instrument will capture all test values corresponding to the three pilot frequencies in the active band. When measuring is completed, it will offer the options to store data or to start a new acquisition.

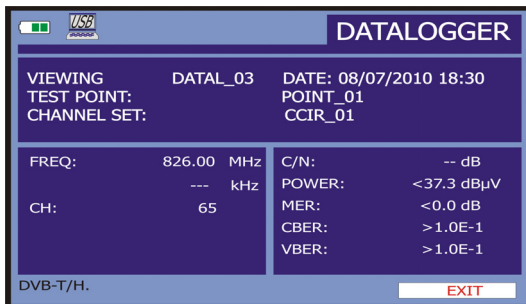



Figure 15.- End of data acquisition.

NOTE: In order to select the function (Attenuation test or **IF SAT** test) might be necessary to switch the frequency band between Terrestrial or Satellite by means of the front panel  key [14].



5.11 Verification of distribution networks (SAT IF Test / Attenuation Test)

This application allows to verify easily the TCI features (Telecommunications Common Infrastructures) before the antennas and head-end devices are operative. The procedure allows to evaluate the frequency response of a whole TV signals distribution network by means of two steps:

NOTE: For this application the use of **PROMAX RP-050, RP-080, RP-110** or **RP-250** signal generators are required, for which they have been specially designed. If you use a generator that emits not modulated carriers, this may cause a slight uncalibration during the **SAT IF TEST**.

1.- CALIBRATION

Connect the generator directly to the **TV EXPLORER HD DTMB** using the **BNC-F** adapter.

Power the signal generators of the **RP PROMAX** family through the **TV EXPLORER HD DTMB** or an external power supply. To set the **External supply** function (see section '5.7 External Units Power Supply') press the  [11] key, and the rotary selector  [1] to set a voltage of 13 V.

Finally, select the **SAT IF TEST** application on **UTILITIES**  [22] menu for SAT band, or the **ATTENUATION TEST** for terrestrial band, connect the generator to the point where the antenna will be connected (signal source).

Press the  [17] key to see on screen the measurement **CONFIGURATION**. By means of the Threshold Attenuation option is possible to adjust the maximum difference between the pilots reference level from 5 to 50 dBmV.

Later, by means of the horizontal cursors  [6] key, select the Calibrate function (see the following figure). Wait for some seconds until the calibration process for three pilots is completed: **MEASURING REF.** is indicated on screen while this process is in progress.

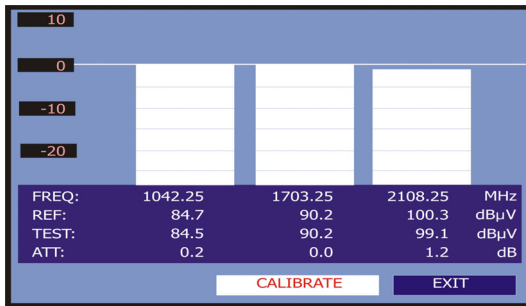



Figure 16.- SAT IF Test. Satellite band.

The calibration process must be carried out over the point of the installation which is taken as reference, i.e. usually the headend. During this process is determined the number of pilot frequencies to check, from one to three, in addition to the reference level for pilots. In order to determine the number of pilots, the equipment takes the higher found level and verifies that the other pilots have a non lower level to the reference one plus the defined threshold level. If the pilot agrees this condition it will show on screen.

The user can also define the pilot frequencies:

Press the key  [17] to show on screen the **CONFIGURATION** menu of the measure. The **PILOTS** function allows you to set pilot signals manually. To do this, using the rotary selector  [1] select that function and change it to **MANUAL**. You will see a menu where you can set the frequency of each of the 3 pilot signals. If you want to return to the automatic generation of pilot signals, change back **PILOTS** function to **AUTO**.

2.- MEASUREMENT OF THREE PILOTS THROUGH THE NETWORK

Once **TV EXPLORER HD DTMB** has been calibrated, start to make level measurements in the different distribution outlets using the **TV EXPLORER HD DTMB**. On the screen will appear the attenuation values for the three pilot frequencies measured in the outlet plate (see the following figure).

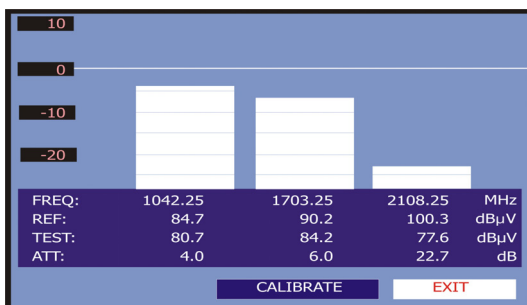



Figure 17.- Attenuation measurements in an outlet plate.

In order to finish measuring, press the rotary selector  [1] and select the (EXIT) option.

5.12 Spectrum exploration function (EXPLORER)

The **Exploration** function allows exploring the full frequency band in order to identify the analogue channels and digital presents, in agreement with the configuration set, over the active channel plan. In order to activate the function hold pressed the  [25] key until the **EXPLORER** screen appears.

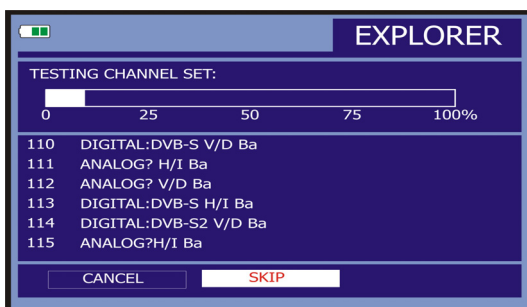





Figure 18.- Spectrum exploration screen. **EXPLORER**.

When the instrument completes the exploration, a new channel plan is generated based on the active channel plan. This new channel plan contains only the channels that have been identified and the rest are removed. The equipment offers the possibility of saving in memory the channel plan generated to use later. If the new channel plan is not saved it will remain active until the instrument is powered off or some other plan is loaded.



NOTE: In the case that is desired to explore or identify **DVB-C** signals will be necessary to select previously **DVB-C** standard as digital signal identifier by means of  [22] **PREFERENCES** menu.

5.13 Measurements configuration

With the aim of taking the measurements of all types of signals some times could be necessary that user enters parameters relative to particular characteristics of these signals, whether an automatic detection has not been possible, or these parameters differ from the standard corresponding ones.

Press the **Measurements Configuration**  [17] key to access to the **CONFIGURATION** menu and turn the rotary selector  [1] to access to parameters which are modifiable by the user.

5.13.1 DVB-C (QAM) Digital Channel Configuration

Press the **Measurements Configuration**  [17] key to access to the **CONFIGURATION** menu and turn the rotary selector  [1] to access the **QAM** signals parameters, which can be defined by user and are described below:

- 1) **Channel BW** (channel bandwidth)
 Enables the channel bandwidth to be selected up to 9.2 MHz. The selection of this parameter is essential for the correct operation of the tuner, as it affects the frequency separation of the carriers.

 The user can modify the bandwidth and then the symbol rate will change according to the bandwidth, but once the demodulator locks a signal, the bandwidth will change according to the symbol rate detected.
- 2) **Spectral inversion**
 If necessary, activate the **Spectral inversion (On)**. If the spectral inversion is not correctly selected, reception will not be correct.
- 3) **Symbol Rate**
 When selecting this function and pressing the rotary selector  [1] is possible to choose the symbol rate.

4) **Modulation**

It defines the modulation type. When selecting this function and turn the rotary selector  [1] to choose one of the following modulations: **16, 32, 64, 128** and **256**.

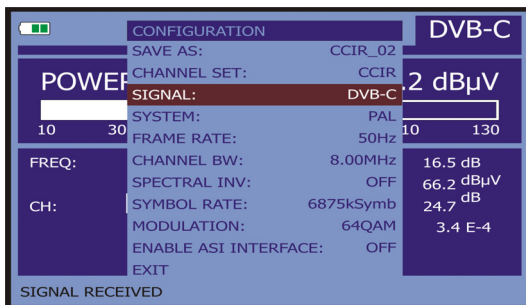

Figure 19.- Screen of measurement configuration (**QAM** signals).

5.13.2 DTMB Digital Channel Configuration

This configuration menu shows, the value of the signal parameters detected automatically:

Channel BW	Fixed to 8 MHz in DTMB configuration.
Code Rate	FEC protection ratio: 0.40, 0.60, 0.80.
Constellation	Carriers modulation. It also defines the system noise immunity. QAM4NR, QAM4, QAM16, QAM32, QAM64.
Time Interleaver	240, 720.
Frame Header	The frame header corresponds to the dead time between symbols, its purpose is to permit a connect reception in multi-path situation: 420, 595, 945.
Carrier Mode:	Multiple or Single.

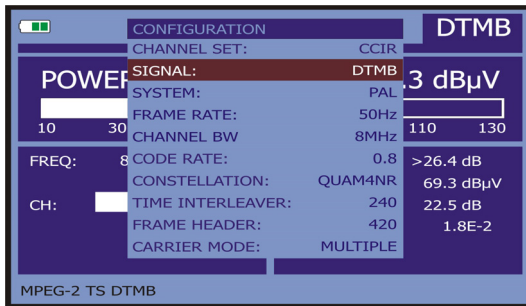

Figure 20.- Screen of measurement configuration (DTMB signals).

5.13.3 DVB-S/S2 (QPSK/8PSK) Digital Channel Configuration

Press the **Measurements Configuration** [17] key to access to the **CONFIGURATION** menu and turn the rotary selector [1] to access the **QPSK/8PSK** signals parameters which can be defined by user and are described below:

- 1) **Channel BW** (channel bandwidth)
Enables the channel bandwidth to be selected over a range from 1.3 MHz to 60.75 MHz. The selection of this parameter is essential for the correct operation of the tuner, as it affects the frequency separation of the carriers. If you change the bandwidth the **Symbol Rate** changes proportionally and vice versa.
- 2) **Spectral Inv**
If necessary, activate the **Spectral inversion (On)**. Reception will be bad if spectral inversion has been incorrectly selected.
- 3) **Code Rate**
Also known as Viterbi ratio. It defines the ratio between the number of data bits and actual transmission bits (the difference corresponds to the control bits for error detection and correction).
In **DVB-S** it permits to choose between **1/2, 2/3, 3/4, 5/6** and **7/8**. In **DVB-S2** it permits to choose one of the following values: **1/4, 1/3, 2/5, 1/2, 3/5, 2/3, 3/4, 4/5, 5/6, 8/9** y **9/10**.
- 4) **Symbol Rate**
It is possible to choose over the following values: from **1000** to **45000** kbauds.
When selecting the option appears the current value, in order to modify it enter a new value through keyboard when appears the data enter symbol appears on the power left corner screen.

When altering this parameter modifies automatically the value of the **Channel Bandwidth** and vice versa, due to the relation that exists between these two parameters.

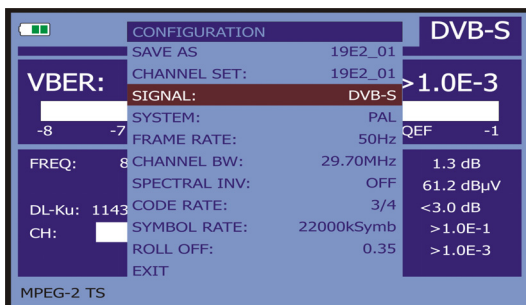

Figure 21.- Measurement configuration screen (QPSK signals).

- 5) **Modulations** (Only in DVB-S2)
Modulation used by carriers. It defines also the system noise immunity (QPSK and 8PSK).
- 6) **Polarization**
It affects to the signal reception in the SAT band (satellite). It allows to select the signal polarisation among **Vertical/Right** (vertical and circular clockwise) and **Horizontal/ Left** (horizontal and circular counter clockwise) or, to deactivate the polarization (**OFF**).
- 7) **Sat Band**
Selects the High or Low frequency band for satellite channel tuning.
- 8) **LNB Low Osc.**
Sets the LNB low band local oscillator.
- 9) **LNB High Osc.**
Sets the LNB high band local oscillator (up to 25 GHz).

NOTE: In the channel tuning mode the **Polarization** and **Sat Band** options cannot be modified.



This configuration menu shows, besides the **QPSK/8PSK** signal parameters selected by user, all the values automatically detected:

Roll Off Nyquist filter roll-off factor.

Pilots (Only in DVB-S2) Pilots detection in transmission.

IMPORTANT REMARK

DVB channels tuning may require an adjusting process. It is recommended to follow next procedure:

1. From the **spectrum analyser mode**  [13], tune the channel at its central frequency.
2. Switch to **Measurements mode**  [12], measurement selection.
3. If in the lower line of the screen does not appear **MPEG-2** message (and consequently BER is unacceptable), by turning the rotary selector deviate the tuning frequency until **MPEG-2** message appears. Finally tune channel again to minimize the **frequency deviation which optimises the BER** and therefore minimize the BER.

If it is not possible to detect any MPEG-2 channel, make sure that digital signal parameters are correctly defined.

5.14 Selecting the Measurements

The types of measurements available depend on the operating band (terrestrial or satellite) and the type of signals (analogue or digital).

Terrestrial band - Analogue channels:

Level	Level measurement of the currently tuned carrier.
Video / Audio	Video carrier to audio carrier ratio.
C/N	Ratio between the modulated signal power and the equivalent noise power for a same bandwidth. (according to TV standard)
FM Deviation	Measure the frequency peak deviation for any modulated analogue carrier in FM .

Terrestrial band - Digital channels (DVB-C, DTMB and ITU-T J.83/B):

Channel power	Channel power is measured assuming that power spectral density is uniform throughout channel bandwidth. To measure it correctly it is indispensable to define the Channel BW .
C/N	Out-channel measurement. Noise level is measured at $f_{noise} = f_{tuning} \pm \frac{1}{2} * Channel\ BW$. To measure it correctly digital channel must be tuned at its central frequency.

MER	Modulation error ratio with noise margin indication.
CBER (only for DVB-C and ITU-T J.83/B)	BER measurement (Bit error rate) for the digital signal before error correction (BER before FEC).
LBER (only for DTMB)	BER measurement (Bit error rate) for the digital signal after error correction (BER after LDPC).

Satellite band - Analogue channels

Level	Level measurement of the currently tuned carrier.
C/N	Ratio between the modulated signal power and the equivalent noise power for a same bandwidth.

Satellite band - Digital channels (DVB-S/S2):

Channel Power	<i>Automatic method.</i>
C/N	Ratio between the modulated signal power and the equivalent noise power for a same bandwidth.
MER	Modulation Error Ratio. Complementary measurement of the Noise Margin for DVB-S and the Link Margin for DVB-S2 .
CBER	The BER measurement (Bit error rate) for the digital signal before error correction (BER before FEC).
VBER	(Only for DVB-S) The BER measurement (Bit error rate) for the digital signal after error correction (BER after Viterbi).
LBER	(Only for DVB-S2) The BER measurement (Bit error rate) for the digital signal after error correction (BER after LDPC).

In order to change the measurement highlighted, press the  [12] key. On the monitor will appear cyclically all the measures available for the signal on tune.

5.14.1 Analogue TV: Measuring the Video Carrier Level

In the measurement mode of analogue signals, the TV EXPLORER **HD** DTMB, monitor can work as an analogue indicator of level representing the signal present in the input.

In order to change the measurement mode press  [12], it will appear a screen like the following one:

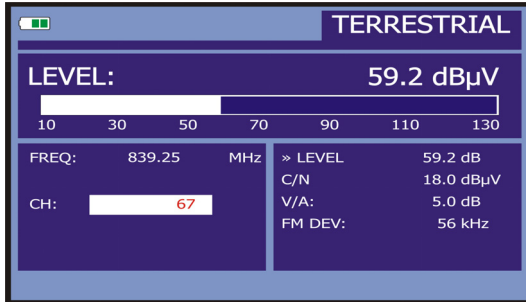



Figure 22.- Analogue signal level measurement in terrestrial band.

Turn the rotary selector  [1] to change the tuning channel/frequency. Press the  [12] key to select the type of measurement to highlight on the monitor.

The available types of measurements are:

- LEVEL:** Level indication on the upper part of the screen (analogue bar).
- C/N:** Carrier/Noise ratio measurement.
- V/A:** Video/Audio ratio measurement.
- FM Deviation:** Measure the frequency peak deviation for any modulated analogue carrier in **FM**.

WARNING

When at the RF input appear an important number of carriers with a high level the tuning circuit may become out of control, giving as a result wrong level measurements. To be able to determinate the equivalent level of a carrier group (with similar levels) at the RF input, it is possible to use the expression:

$$L_t = L + 10 \log N$$

- L_t : equivalent total level
- L : average level of the carriers group
- N : number of carriers

So, if there are ten carriers with a level around 90 dB μ V, their equivalent level will be:

$$90 \text{ dB}\mu\text{V} + 10 \log 10 = 100 \text{ dB}\mu\text{V}$$

Observe that in this case, loss of tuning by overload of the RF input may occur besides other effects such as tuner saturation and generation of intermodulation products that may mask the spectrum visualization.

5.14.2 Analogue TV: Measuring the Video / Audio ratio (V/A)

In the **Audio/Video** measurement mode, on the screen appears the following information:

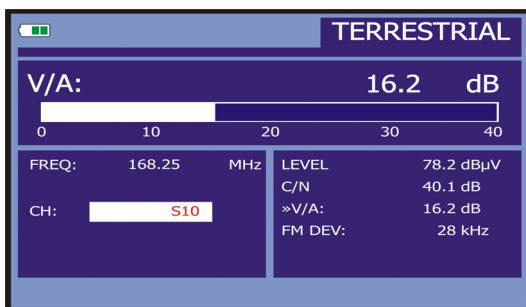

Figure 23.- Measurement of the video/audio ratio.

In addition to the video carrier / audio carrier level ratio (16.2 dB in previous figure) it also shows the frequency or channel, depending on the tuning mode selected, and the Carrier/Noise ratio.

5.14.3 Analogue TV: Measuring the FM deviation

The TV EXPLORER **HD DTMB** measure the deviation in frequency of any modulated analogue carrier in **FM**. This function allows visualising frequency peak deviation for **FM** carrier signals.

Once this **DESV FM** measurement mode is activated will appear the following information on screen:

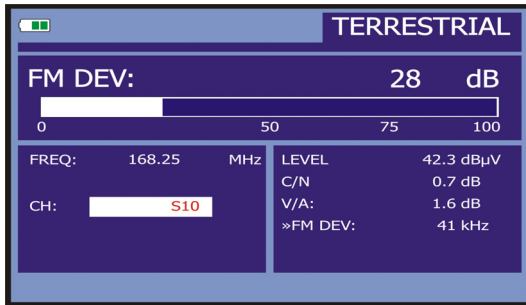



Figure 24.- FM carrier peak deviation.

On the screen appears the deviation peaks in order to observe if they are within a suitable range limit valid for both, the receiver and the transmitter in the transmitting system.

5.14.4 Analogue FM: Measuring the Level and demodulating signal

Press the **Measurement Configuration**  [17] key to accede to the **CONFIGURATION** menu and turn the rotary selector  [1] in order to select the analogue FM signal. In the **analogue FM** measurement mode, the **TV EXPLORER HD DTMB** display works like an analogue level indicator showing the signal level present in the input.

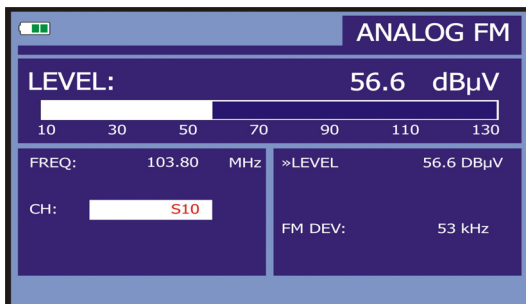

Figure 25.- FM analogue signal measurement.

The instrument also demodulates the FM carrier (radio) and allows to listen sound through the loudspeaker [33].

5.14.5 Analogue/Digital TV: Measuring the Carrier / Noise ratio (C/N).

The TV EXPLORER **HD** DTMB carries out **C/N** ratio measurement in four different ways, according to the carrier type and the used band:

A) Terrestrial band, analogue carrier

Carrier level is measured using a quasi-peak detector (230 kHz BW). Noise level is measured with an average detector and corrected to refer it to channel equivalent noise bandwidth (according to the definition of the selected standard).

B) Terrestrial band, digital carrier

Both measurements are done with an average detector (230 kHz) and the same corrections are introduced on them (bandwidth corrections).

C) Satellite band, analogue carrier

Carrier level is measured using a quasi-peak detector (4 MHz BW). Noise level is measured with an average detector (230 kHz) and corrected to refer it to channel bandwidth.

D) Satellite band, digital carrier

Equivalent to case B but now using the 4 MHz BW filter.

On selecting the **Carrier / Noise** measurement mode the screen displays the following information:

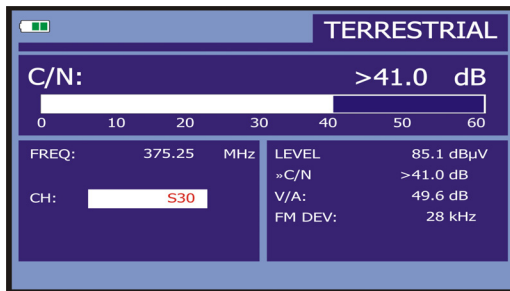







Figure 26.- Carrier-to-noise ratio measurement (C/N).

As well as the video carrier / noise level ratio (**C/N**) (41.0 dB in previous figure), the frequency or channel (depending on the tuning mode selected) and the *level* of the *video carrier* and *video/audio ratio* are also shown. When representing the spectrum by means

of pressing  [13] key, the **NOISE** cursor is automatically positioned to a side of the carrier tuned. That is, the cursor will indicate the point where the value of the noise is

lower, whenever the C/N (AUTO) option is selected from the **PREFERENCES**  [22] menu. If the C/N (MANUAL) option has been activated the frequency where noise level will be measured will correspond to the position of the vertical discontinuous green-

coloured cursor that appears in the spectrum graph  [13].

In order to modify this frequency, press the **measurement configuration**  [17] key, to accede to the **CONFIGURATION** menu. By turning the rotary selector  [1], locate the **NOISE** cursor on the position of the marker using **NOISE FREQ. TO MARKER** option (see section “5.16.1 Markers”) or directly enter the value of the new noise frequency by means of **NOISE FREQ** option.

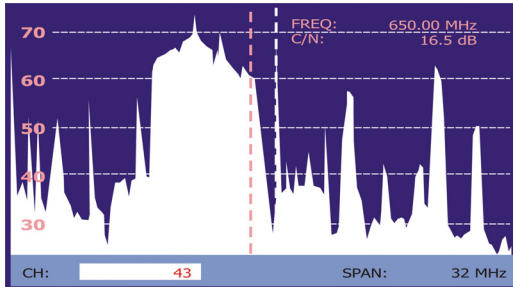

Figure 27.- NOISE cursor. C/N (MANUAL).

When measuring channels in the satellite band or digital channels, to measure the C/N ratio correctly, the bandwidth of the channel must be defined previously, using the **Channel BW** option on the **Measurements Configuration** menu that appears when

pressing the  [17] key.

IMPORTANT REMARK

In order to measure digital channel C/N ratio it is indispensable to tune channel at its central frequency.

In the case of the presence of adjacent digital channels, these could mask the noise level measurement.

5.14.6 Digital TV: Measuring the Power of Digital Channels

The **TV EXPLORER HD DTMB** measures digital channel power in the measurement filter bandwidth and estimates total channel power assuming that spectral density is uniform throughout channel bandwidth.

On selecting the **CHANNEL POWER** measurement mode, the screen displays the following information:

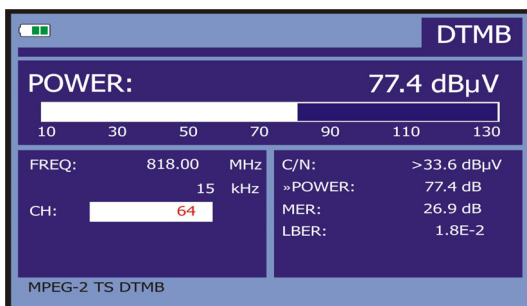



Figure 28.- Digital channel power measurement.

In addition to the power of the digital channel (77.4 dB μ V in previous figure) this also shows the tuning frequency or channel, depending on the tuning mode selected, and the offset frequency to calculate the digital channel power and the deviation frequency of the central tuning calculated by the demodulator, measurement that indicates the adjustment in the channel tuning.

For the power measurement of a digital channel to be correct it is essential to have previously defined the channel bandwidth using the **Channel BW** option, in the **Measurements Configuration** menu that appears when pressing  [17] key.

5.14.7 Digital TV: Measuring BER

The **TV EXPLORER HD DTMB** offers three ways to measure the error rate (**BER**) of digital signals depending on the type of used modulation.

To select the **BER** measurement mode:

- 1) Select digital signals **Measurements Configuration** pressing  [17] key.

- 2) Select by means of **Signal** option from **CONFIGURATION** menu: **DVB-C** for the measurement of **QAM** modulated signals, **DTMB** for the measurement of **DTMB** modulated signals or **DVB-S/S2** for the measurement of **QPSK/8PSK** modulated signals.
- 3) Enter the parameters relative to the digital signal which appear in the measurement **CONFIGURATION** menu, as described previously.
- 4) Select the option to exit from measurements **CONFIGURATION** menu.

5.14.7.1 ITU-T J.83/B signals

Once determined the parameters of **QAM Annex-B** signal, it will be possible to measure **BER**, press the  [12] key until the **BER** measurement display appears.

In the **BER** measurement mode, the monitor will show a display like the following one:

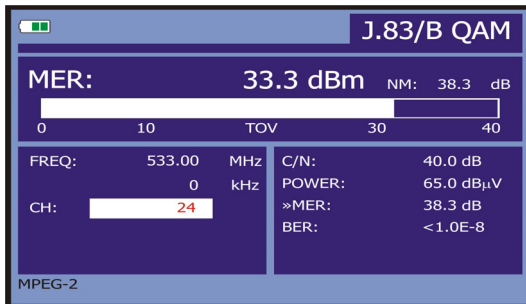

Figure 29.- Screen of **BER** measurement of **QAM Annex-B** signals.

The **BER** measurement before error correction is shown: **BER before FEC** (Forward Error Correction).

In a digital reception system for cable signals, after the **QAM Annex-B** demodulator an error correction method called **Reed-Solomon** is applied (see following Figure). Obviously, the error rate after the corrector is lower to the error rate at the **QAM Annex-B** decoder output. This is the reason because this screen provides the **BER** measurement before FEC (Forward Error Correction).

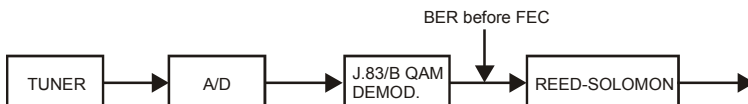



Figure 30.- Digital reception system via cable.

The **BER** measurement is provided in scientific notation (i.e. 1.0 E-5 means 1.0×10^{-5} that is to say one wrong bit of every 100.000) and through an analogue bar (as its length is smaller the signal quality will be better). The analogue representation is done on a logarithmic scale (not linear).

5.14.7.2 DVB-C signals

Once determined the parameters of **QAM** signal, it will be possible to measure **BER**, press the  [12] key until the **BER** measurement display appears.

In the **BER** measurement mode, the monitor will show a display like the following one:

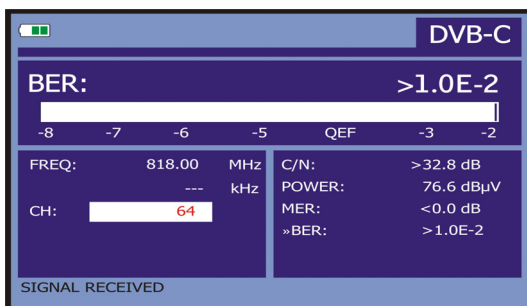

Figure 31.- DVB-C (QAM) signals **BER** measurement screen.

The **BER** measurement before error correction is shown: **BER before FEC** (Forward Error Correction).

In a digital reception system for cable signals, after the **QAM** demodulator an error correction method called **Reed-Solomon** is applied (see following Figure). Obviously, the error rate after the corrector is lower to the error rate at the **QAM** decoder output. This is the reason because this screen provides the **BER** measurement before FEC (Forward Error Correction).

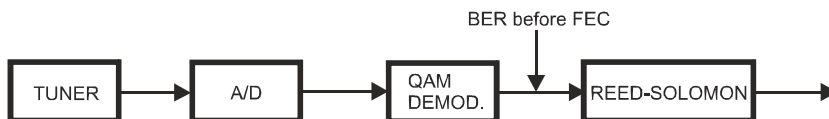



Figure 32.- Digital reception system via cable.

The **BER** measurement is provided in scientific notation (i.e. 1.0 E-5 means 1.0×10^{-5} that is to say one wrong bit of every 100,000) and through an analogue bar (as its length is smaller the signal quality will be better). The analogue representation is done on a logarithmic scale (not linear).

With the aim to have a reference about the signal quality, it is considered that a system has a good quality when it decodes less than one non-correctable error for every transmission hour. This border is known as **QEF (Quasi-Error-Free)** and it corresponds approximately to a BER before FEC of **2.0E-4 BER** (2.0×10^{-4} , that is to say two incorrect bits of every 10,000). This value is marked on the measurement bar of the **BER** and therefore, **BER** for acceptable signals must be at the **left** side of this mark.

Below the **BER** analogue bar it is shown the tuned frequency (or channel) and the frequency deviation in kHz between the tuned frequency and the one, which optimises the BER (i.e. 800.00 MHz + 1.2 kHz). This deviation must be adjusted specially from the **C/N** measurement in satellite band, by tuning again the channel in frequency mode

 [24], to the lower reachable value.

5.14.7.3 DTMB signals

Once determined the parameters of **DTMB** signal, it will be possible to measure **BER**.

Following is shown the **BER** measurement after the **LDPC** error correction: **the LBER**.

In a **DTMB** digital reception system, after the decoder other two different correction methods are applied (see following Figure). In this case, as the previous one, each time we apply an error corrector to a digital signal, the error rate changes, therefore if we measure, for example, the error rate at the output of the **DTMB** demodulator, at the output of the **Low Density Parity Check (LDPC)** decoder, and at the output of the **BCH** decoder, we obtain nothing more than different error rates. This is the reason because the **BER** measurement is provided after **LDPC (LBER)**. It also shows the LDPC iterations, which is the number of times that the **LDPC** error corrector goes through the signal.

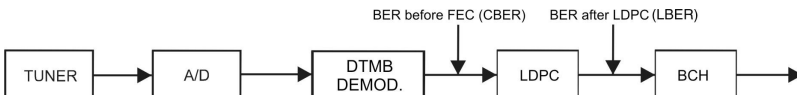

Figure 33.- Digital reception system via terrestrial. (DTMB).

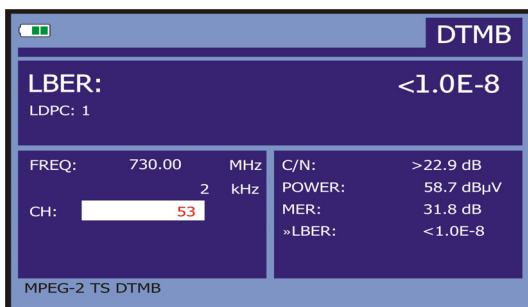

Figure 34.- DTMB signals LBER measurement screen.

The **LBER** measurement is provided in scientific notation (i.e. $1.0 \text{ E-}8$ means 1.0×10^{-8} , that is to say one incorrect bit of every 100.000.000) as its value is smaller the signal quality will be better).

Next it is shown the tuning frequency and the frequency deviation in kHz between the tuned frequency and the one, which optimizes the **LBER**. (for example Freq.: 730 MHz+ 2 kHz).

Finally it is shown a status line with information about the detected signal. The possible messages that can appear and its meaning are showing the following list. The messages are exposed from less to more fulfilment of the **MPEG-2** standard:

No signal received

No signal has been detected.

Signal received

A signal is detected but it can not be decoded.

MPEG-2 TS DTMB

Correct detection of a MPEG-2 DTMB signal.

5.14.7.4 DVB-S/S2 signals

Once determined the parameters of **QPSK** signal, it will be possible to measure **BER**. Following is shown the *BER measurement before the error corrections*: **BER before the FEC**: **CBER**.

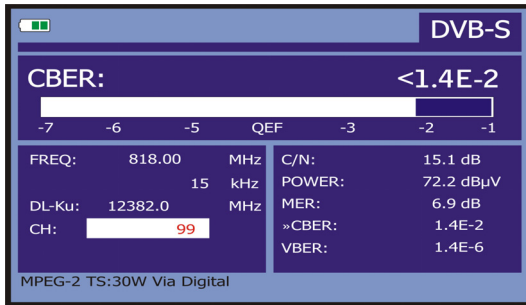

Figure 35.- DVB-S (QPSK) signals CBER measurement screen.

In a digital reception system for satellite signals (DVB-S), after the QPSK decoder two different correction methods are applied (see following Figure). Obviously, each time we apply an error corrector to a digital signal, the error rate changes, therefore if we measure in a digital satellite television system, for example, the error rate at the output of the QPSK demodulator, at the output of the Viterbi decoder, and at the output of the Reed-Solomon decoder, we obtain nothing more than different error rates. This is the reason because the BER measurement is provided before FEC, after Viterbi (VBER).

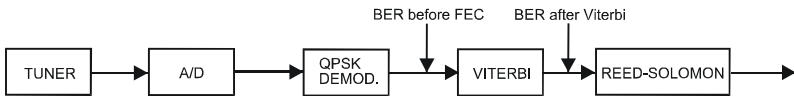

Figure 36.- Digital reception system via satellite. (DVB-S)

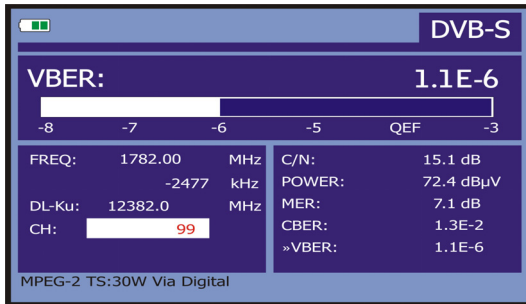

Figure 37.- DVB-S (QPSK) signals VBER measurement screen.

In a digital reception system for satellite signals (**DVB-S2**), after the **QPSK** decoder other two different correction methods are applied (see following Figure). In this case, as the previous one, each time we apply an error corrector to a digital signal, the error rate changes, therefore if we measure in a digital satellite television system, for example, the error rate at the output of the **QPSK/8PSK** demodulator, at the output of the Low Density Parity Check (**LDPC**) decoder, and at the output of the **BCH** decoder, we obtain nothing more than different error rates. This is the reason because the **BER** measurement is provided after **LDPC** (**LBER**). It also shows the amount of packet errors (**PER**), that is, the amount of packets receiving during the measurement time, which are not correctable by the demodulator (**WP**).

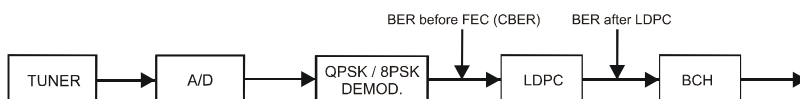

Figure 38.- Digital reception system via satellite. (DVB-S2).

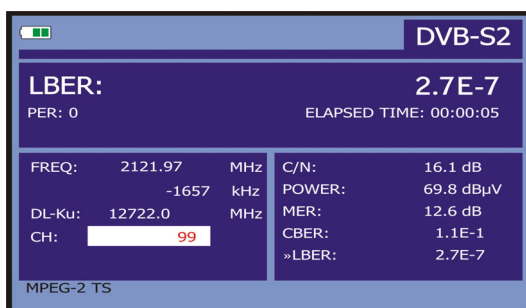

Figure 39.- DVB-S2 (QPSK/8PSK) signals **LBER** measurement screen.

The **BER** measurement is provided in scientific notation (i.e. $2.7 \text{ E-}7$ means 2.7×10^{-7} , that is to say two incorrect bits of every 10,000,000) and through an analogue bar (as its length is smaller the signal quality will be better). The analogue representation is done on a logarithmic scale (not linear).

With the aim to have a reference about the signal quality, it is considered that a system has a good quality when it decodes less than one non-correctable error for every transmission hour. This border is known as **QEF (Quasi-Error-Free)** and it corresponds approximately to a **BER after Viterbi of $2.0\text{E-}4$ BER (2.0×10^{-4})**. This value is marked on the measurement bar of the **BER** after Viterbi and therefore, **BER** for acceptable signals must be at the **left** side of this mark.

Next it is shown the tuning frequency and the frequency deviation in MHz between the tuned frequency and the one, which optimises the **BER**.

Finally it is shown a status line with information about the detected signal. The possible messages that can appear and its meaning are shown in the following list. The messages are exposed from less to more fulfilment of the **MPEG-2** standard:

No signal received

Any signal has been detected.

Signal received

A signal is detected but it can not be decoded.

Carrier recovered

A digital carrier has been detected but it can not be decoded.

Viterbi synchronized

A digital carrier has been detected and the Viterbi algorithm is synchronized, but too many frames arrive with non correctable errors. It is not possible to quantify the BER.

MPEG-2 TS DVB-S

Correct detection of a MPEG-2 signal.

5.14.8 Digital TV: Measuring MER

Once determined the suitable parameters for **DTMB**, **QAM**, **QPSK** or **8PSK** signal reception, it will be possible to measure **MER**, press  [12] key until it appears the **MER** measurement screen.

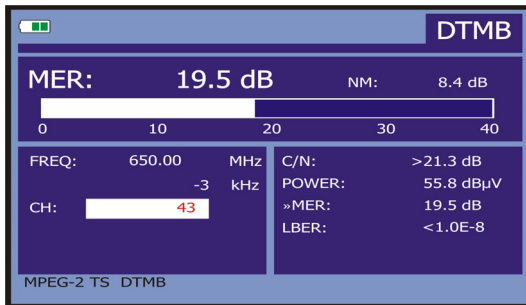

Figure 40.- DTMB (COFDM) signals MER measurement screen.

First of all, you will see the *modulation error ratio* measurement: **MER**.

Following, it appears the Noise Margin (**NM**) measurement (in the figure value 8.4 dB). It indicates a safety available margin according to the **MER** level measured that allows signal degradation until arriving to the **QEF** (*Quasi-Error-Free*) limit value.

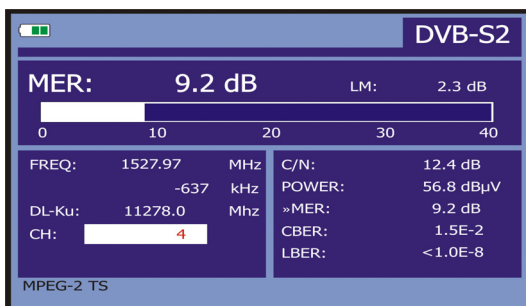

Figure 41.- DVB-S2 (QPSK/8PSK) signals MER measurement screen.

In the case of a **DVB-S2** signal (**QPSK/8PSK**) instead of the Noise Margin (**NM**) appears the measure of the **Link Margin (LM)**; in the previous figure with a value of 2.3 dB. The **LM** is equivalent to the **NM** and indicates the distance to the **QEF** (generally defined as one lost packet per hour). The **LM** is measured in dB and its value is equal to the safety margin that separates us from the **QEF**. As bigger **LM** better signal quality. An **LM** with a negative value means that there is no signal reception or errors are beginning to display clearly in the video or the audio. An **LM** equal to 0 (zero) displays a service and occasionally some artefacts can be observed.

Analogue and digital carriers are very different in terms of signal contents and power distribution over the channel. They, therefore, need to be measured differently. The modulation error ratio (**MER**), used in digital systems is similar to the Signal/Noise (**S/N**) ratio in analogue systems.

MER represents the relation between the average power of **DVB** signal and the average power of noise present in the constellation of the signals.

When measuring **MER**, it also shows the noise margin in **DTMB, C, S** and the Link margin in **DVB-S2**, which indicates the distance from the **QEF** point at the current signal.

By example, **QAM 64** demodulators require a **MER** greater than **23 dB** to work. Though it is preferable to have at least a **3** or **4 dB** margin to compensate for any possible degradation of the system. While **QAM 256** demodulators require a **MER** greater than **28 dB** with margins of at least **3 dB**. Normally, the maximum **MER** value seen in portable analysers is of approximately **34 dB**.

Finally it is shown a status line, which displays information about the detected signal.

5.15 Constellation Diagram

The constellation diagram is a graphic representation, of the digital symbols received over a period of time.

There are different types of constellation diagrams for the different modulation modes. With the **TV EXPLORER HD DTMB** it is possible to display constellations for **DTMB, DVB-C, DVB-S** and **DVB-S2** signals.

In the case of an ideal transmission channel, free of noise and interferences, all symbols are recognised by the demodulator without mistakes. In this case, they are represented in the constellation diagram as well defined points hitting in the same area forming a clear dot.

Noise and impairments cause the demodulator to not always read the symbols correctly. In this case the hits disperse and create different shapes that at the end will allow to determine at a glance the type of noise in the signal

Each type of modulation is represented in a different way. A 16-QAM signal is represented on screen by a total of 16 different zones and a 64-QAM is represented by a diagram of 64 different areas and so on.

The constellation shows in different colours the density of hits and includes zooming, scrolling and clearing functions for a better graph representation on screen.

5.15.1 ITU-T J.83/B (QAM-Annex B) signal

Go to the **UTILITIES** menu by pressing the  [22] key, and then select the **CONSTELLATION** option.

For example the modulation type: **ITU-T J.83/B** is showed on screen. Next, the frequency and channel number corresponding to the channel plan.

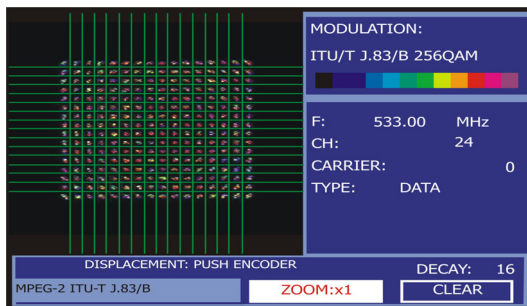



Figure 42.- Constellation Diagram. MPEG-2 TS ITU-T J.83/B.

The TV EXPLORER **HD** DTMB also includes, a **ZOOM** function to enlarge graphic representation over one single quadrant. Select the **SCROLL** option to move the focus

over the whole viewing area using arrow cursors  [6] key, **CLEAR** option to reset the graph screen or **SHARP** option to increase the image clearness over a range from 0 (minimum visual persistence) to 16 (maximum visual persistence).

NOTE

The transmission quality is visualized in a qualitative way using a colour range for the symbol density concentrated in a certain area. This colour coding goes from black (no symbols) to red (maximum density), and runs from blue to yellow in ascending order.

A greater dispersion of the symbols indicates greater level of noise or worse signal quality.

If concentration of symbols or noise appears is indicative of good carrier/noise ratio or absence of problems as phase noise, etc.,.

5.15.1.1 Zoom, scroll and erasing functions

The TV EXPLORER **HD** DTMB also includes, a **ZOOM** function to enlarge graphic representation over one single quadrant. Select the **SCROLL** option to move the focus

over the whole viewing area using arrow cursors  [6] key, **CLEAR** option to reset the graph screen or **SHARP** option to increase the image clearness.

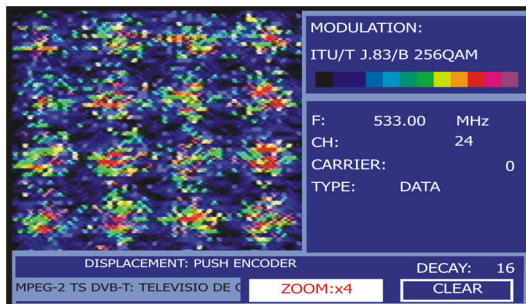



Figure 43.- Zoom x2 constellation diagram.

5.15.2 DTMB signal

Activate the **UTILITIES** menu by pressing the  [22] key, and select the **CONSTELLATION** option. Now, on screen will be recorded the hits due to symbols received during the digital signal transmission.

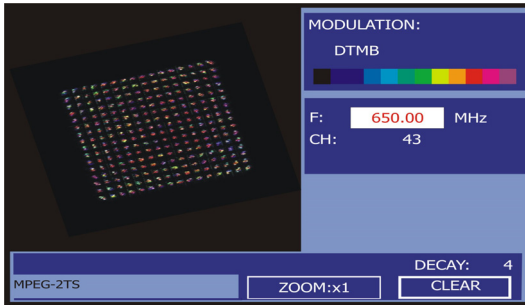



Figure 44.- Constellation Diagram. **DTMB (QAM 256)** signal.

By means of the rotary selector  [1] and the arrow cursors  [6] key, is possible to change the frequency or channel.

The **DECAFY** option sets the visual persistence for symbol impacts on the screen in a range from 0 (minimum) to 16 (maximum).

First appears the information about the type of modulation **DTMB (QAM-256)**. Next it is indicated the frequency, the channel and the carrier tuned. It is also indicated the carrier type (data or pilot). Finally, it shows the status line (similar to the measurement screen).

NOTE

The transmission quality is visualised in a qualitative way using a colour range for the symbol density concentrated in a certain area. This colour coding goes from black (no symbols), to red (maximum density), and runs from blue to yellow in ascending order.

A greater dispersion of the symbols indicates greater level of noise or worse signal quality.

If concentration of symbols or noise appears is indicative of good carrier/noise ratio or absence of problems as phase noise, etc.,.

5.15.3 DVB-C (QAM) signal

Sets on the **UTILITIES** menu by pressing the  [22] key, and select the **CONSTELLATION** option.

On screen appears the modulation type: **DVB-C (256 QAM)**. Also the frequency and channel number are indicated. Finally, it shows the type of **DVB-C** broadcast network used.

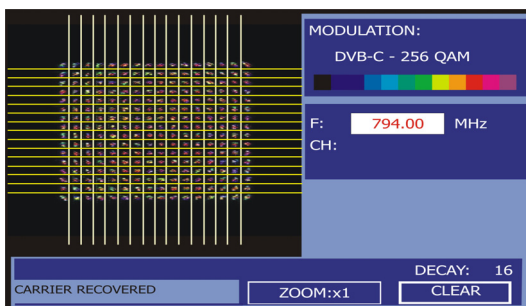

Figure 45.- Constellation diagram. **DVB-C (QAM 256)** signal.

NOTE

The transmission quality is visualised in a qualitative way using a colour range for the symbol density concentrated in a certain area. This colour coding goes from black (no symbols) to red (maximum density), and runs from blue to yellow in ascending order.

A greater dispersion of the symbols indicates greater level of noise or worse signal quality.

If concentration of symbols or noise appears is indicative of good carrier/noise ratio or absence of problems as phase noise, etc.,.

5.15.4 DVB-S/S2 (QPSK/8PSK) signal

Go to the **UTILITIES** menu by pressing the  [22] key, and then select the **CONSTELLATION** option.

The modulation type: **DVB-S (QPSK)** or **DVB-S2 (8PSK)** is showed on screen. Next, the frequency and channel number corresponding to the channel plan selected as well as the satellite downlink frequency. Finally, it shows the status line (similar to the measurement screen).

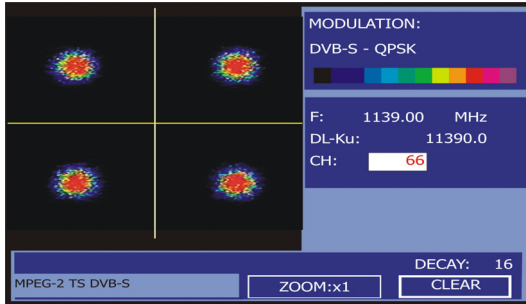

Figure 46.- Constellation Diagram. **DVB-S (QPSK)** signal.

When selecting a constellation diagram for **DVB-S2** signals, on screen will appear the following information:

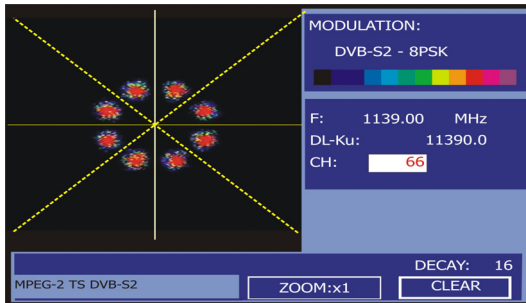

Figure 47.- Constellation Diagram. **DVB-S2 (8PSK)** signal.

NOTE

The transmission quality is visualised in a qualitative way using a colour range for the symbol density concentrated in a certain area. This colour coding goes from black (no symbols) to red (maximum density), and runs from blue to yellow in ascending order.

A greater dispersion of the symbols indicates greater level of noise or worse signal quality.

If concentration of symbols or noise appears is indicative of good carrier/noise ratio or absence of problems as phase noise, etc.,.

5.16 Spectrum Analyser

The **Spectrum Analyser** mode allows the user to discover the signals present in the frequency band in quickly and easily and to make measurements at the same time.

To select it press  [13] key. The monitor will show a picture like the one described in the next figure.

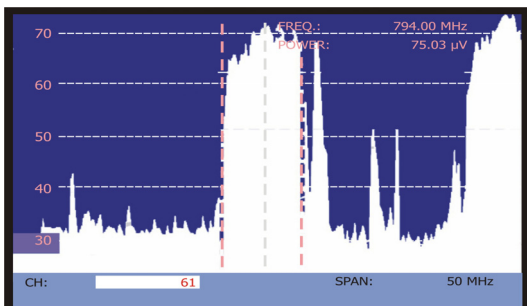





Figure 48.- Spectrum analyser mode.

The horizontal lines define the signal level, the broken lines being separated a distance equals to 10 dB. The level of the top line (70 dB μ V in previous figure), named

Reference Level, can be altered using the vertical cursors  [6] key over a range from 60 dB μ V to 130 dB μ V by steps (from 70 dB μ V to 130 dB μ V in satellite band). The vertical measurement range changes to 5 dB/div by holding pressed the lower arrow cursor key

 [6] and changes to 10 dB/div by holding pressed the upper arrow cursor key  [6].

The signal level for each frequency is displayed vertically, the lower frequencies appear at the left of the screen and the higher ones at the right. The amplitude of the lobes is calibrated. In the example in previous figure the noise level is at around 25 dB μ V and the lobe with the highest signal level (third from the right) is at 70 dB μ V.

In the case that the equipment detects saturation on **RF** input due to an excess of signal, it will appear the icon  in the Spectrum Analyser mode and the message **SYNC: FAIL** in the TV mode to indicate this situation. The user must increase the Reference Level in order to activate an additional attenuator and to avoid the input saturation.

Speed of sweep can be modified for terrestrial TV signals. To that end, press shortly the key  [17] MEASUREMENT CONFIGURATION. On the menu "**Configuration**" it will appear the option "**Sweep**". Entering in this option you can switch between "**Fast**" for a quick sweep of the spectrum or "**Accurate**" for a slower sweep. This option will only appear when you're working with terrestrial TV signals, therefore the led "T" on the front panel must be lighted.

The frequency range displayed (called **span** from hereon) can also be altered using the horizontal cursors  [6] key. Therefore enables selecting the displayed screen frequency range in Spectrum Analyser mode between **Full** (the entire band), **500 MHz**, **200 MHz**, **100 MHz**, **50 MHz**, **32 MHz**, **16 MHz** and **8 MHz** (the latter one only in terrestrial band).



A vertical broken line, called **marker**, appears on the spectrum display to identify the tuned frequency.

One of the applications of the **TV EXPLORER HD DTMB** operating as Spectrum Analyser is in the search for the best orientation and position of the receiving antenna. This is particularly important in UHF. Because such frequencies are involved, with wavelengths ranging from 35 cm to 65 cm, if the antenna is shifted only a few centimetres, the relationship between the picture, chrominance and sound carrier frequencies change, affecting the quality of the picture in the receiver.

If there is an excess of sound carrier, tearing or 'moiré' may appear on the screen due to the frequency beats between the sound, chrominance and the picture frequencies.

If there is a chrominance carrier defect, then the television colour amplifier must function at maximum gain, which could result in noise appearing all over the television screen with points of colour that disappear when the saturation control is reduced; in an extreme case, loss of colour may occur.

5.16.1 Markers

(Only in Spectrum Analyser mode). The marker in red colour indicates the central frequency or tuning frequency, which can be moved by means of turning the rotary selector  [1] as well in channel as in frequency tuning mode  [24].

When monitoring a digital signal spectrum also appears two additional markers in white colour, which indicate the bandwidth of the digital channel (See previous Figure).

If the highlighted measurement which appears on the measurement screen corresponds to C/N, the Spectrum Analyser mode will measure the C/N ratio at the frequency indicated by the marker and a second marker will indicate the frequency for the noise measurement.

5.16.2 Spectrogram.

The Spectrogram is a useful tool and it has been designed to detect problems in a wide range of frequencies. These problems could appear at any time and sporadically.

The Spectrogram function makes a graphical representation of the frequency signal level regards to the time. Each level is represented with a different colour, the Y-axis belongs to frequency and the X-axis to time. Therefore a colour map is showed on the display, see figure 46. Any frequency signal level could be displayed at any time reference using the cursors or the variable knob. This tool is especially useful when a level signal analysis is going to be processed during a long period of time. When the process is finished the capture could be showed and any anomaly will be easily detected at any time.

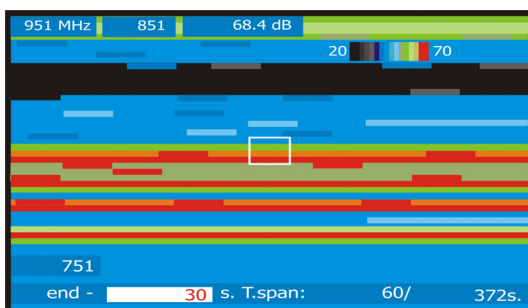



Figure 49.- Spectrogram.

To access the spectrogram, first press the button  [13] to access the spectrum analyser. Then you should set the parameters reference, span and frequency. Then press  [22] and select **SPECTROGRAM** using the cursors or the variable knob. The figure below shows the initial screen.

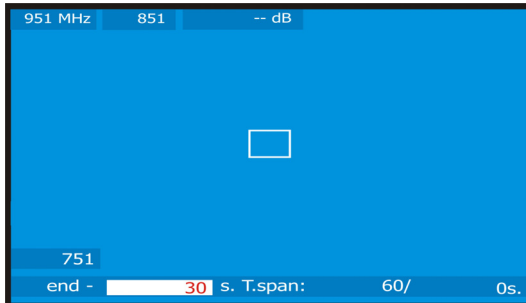

Figure 50.- First Screen.

On the **X-axis** the time variables references are showed. At the bottom right corner, the capture elapsed time is displayed, in seconds. At the bottom center the **T.span** defines the seconds that will be displayed on the screen. For example, if the **T.span** is 60s, therefore the last 60s captured, will be displayed on the screen. On the left corner the **t** variable is at time can be "end - time (s)" or "begin + time (s)".

The tag "end" indicates how many seconds you are from the last capture. To select this option, go to the configuration menu and select the temporal reference "end".

The tag "begin" indicates how many seconds you are from when starting the capture. To select this option, go to the configuration menu and select the temporal reference "beginning".

On the **Y-axis** are placed the frequency variables. In this axis the initial and final frequencies are showed and depend on the Spectrum Analyser configuration. For example if the Spectrum Analyser frequency is 650 MHz and the Spam=100 MHz, the Spectrogram will show as initial frequency 601MHz and end frequency 701MHz.

Next to the final frequency the cursor frequency and its signal level are displayed.

To move among the parameters press the cursor keys **UP** or **DOWN**.

To change a parameter, press the arrow keys **LEFT** or **RIGHT** or use the rotary selector.

5.16.2.1 Spectrogram Configuration

Before the capture begins the options must be configured. Press the key,  [17] and an option menu will be displayed.

Temporal reference

Begin:

The captured information will be showed on the display with initial reference 0 s. In this option the screen is not updated with news acquisitions unless the cursor is moved at the end of the capture.

Using the temporal position, the cursor can be move through the entire file and the display will be updated according to the new temporal reference.

This option is very useful to visualize the captured information. For example if the elapsed time is 500s and we want to show the 200s, this number must be filled in the temporal position. The cursor will be moved to, and the screen will be updated showing the new levels signals.

End:

Selecting this option, the cursor is related to the last acquisition time. If the temporal reference is filled with 0 seconds, the cursor will be placed at the end of the capture, therefore the screen always shows the last acquired data.

This option is very useful if we want to work during the capture process due to the problems can be detected in real time and the cursor can be moved at any temporal reference. When a temporal movement is introduced, noticed that a negative sing is placed before the number by default. This is due to the displayed data on the screen is captured in real time so that if we want to analyse a previous point we should go backward in the time. For example if the elapsed time is 500 s and we want to go to the second 200, the temporal position **t** must be filled with – 300s.

Save

Introduce a name to save the file. If the name already exists a message will be showed and the file could be overwritten or the operation cancelled.

Acquisition mode

Select the different modes to capture a file:

CIRCULAR:

If this option is selected, other menu will be displayed. Choose the file duration. The capture system stores the data in a file during the performed period of time. When the elapsed time is higher than the file, the last captured data will be stored. For example, if the selected file time is 1800s and the elapsed time is 3600, the file will be stored the seconds from 34200 to 36000.

BOUNDED:

If this option is selected, other menu will be displayed. Choose the file duration. When the end of the file arrives, the capture will be stopped and stored.

CONTINUOUS:

The equipment starts the capture and it is not stopped until the user does it manually or the equipment does not have free memory.

OSD INFO

If this option is selected, on the left edge of the screen a heading to connect each signal level (dB) with the respective colour will be showed.

START

Select it to start the capture process.

To finalize the capture manually pres the key  [17] and select STOP.

EXIT

Select it to go to the initial display.

5.16.2.2 Recall a Spectrogram file

Press the key  [22], choose RECALL SPECTROGRAM and select the file with the variable knob. The file will be displayed on the screen. All the file information is available.

The saved files are stored in the folder OTHERS.

5.16.2.3 Delete a Spectrogram file

To delete a Spectrogram capture, press the key  [22] and select the option DELETE CAPTURE. Then it pops up a new menu where you should select SP/. Then select the file you want to delete.



5.17 ECHOES and PRE-ECHOES Analyser (DTMB)

The **ECHOES** Analyser can detect and display echoes that may appear when receiving simultaneously the same signal from several transmitters. Another reason that can cause echoes is the reflection of the signal on large objects such as buildings or mountains. **PRE-ECHOES** are signals received before the main signal arrives.

With the **ECHOES** function is possible to know the distance from where we are to the transmitter or the object that has caused the echo. Thus, the installer can minimise the effects of echoes on the facility. Knowing echoes, the installer is able to reposition the antenna and therefore, reduce the effect of echoes received.

This feature is only available for **DTMB** signals. Therefore, you should configure the **TV EXPLORER HD DTMB** in order to receive this type of signals. If not, the **ECHOES** function will not appear on the menu "Utilities".

The steps to go through to set up the digital terrestrial reception are the next:

1. Press the key  [14] (Satellite / Terrestrial Band) to select the TV terrestrial frequency band.
2. Press the key  [17] (Measurement Configuration) to select the measurement mode for Digital TV.
3. Check the led indicator "D" and the led indicator "T" are lighted.
4. Enter parameters manually to lock signal or press  [25] (Automatic Identification) for an automatic identification of the signal (Figure 47.-).



Figura 51.- Automatic identification of the signal.

Now, the **ECHOES** function is available. The steps to go through in order to select the **ECHOES** function are the next:

5. Press (short pulsation) the key  [22] (Utilities) to access the menu Utilities.
6. Select the option **ECHOES** (Figure 59.-).

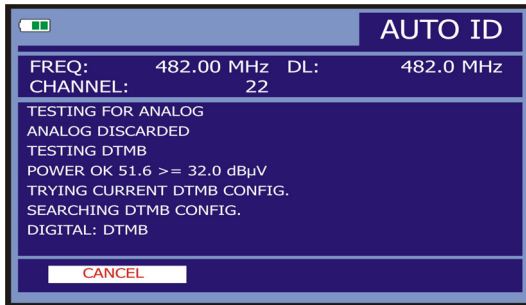

Figure 52.- ECHOES Menu.

7. Press the rotary knob.

It appears the **ECHOES** screen and the **ECHOES** detection starts.

The screen shows a graphical representation of the echoes and a list of the six most important echoes. The horizontal axis of the graph corresponds to the delay in receiving an echo respect to the main path (the most powerful signal). The vertical axis represents the attenuation in dB of the echo respect to the main path. At the top right area there is the frequency and channel tuned.

The user can also zoom in or zoom out the main path area, just selecting the **ZOOM** button on the screen and pressing the rotary knob  [1]. Possible zoom are 1x, 2x, 4x, 8x, 16x, 32x and 64x.

In the list of the echoes parameters, the delay is presented in micro seconds, the distance in kilometres and the attenuation in dB.

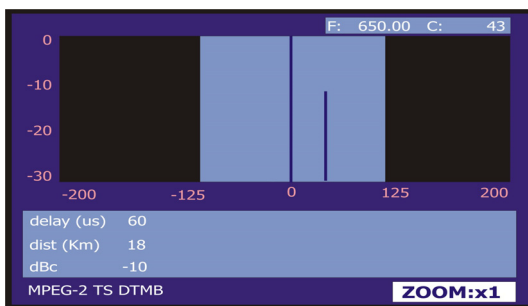

Figure 53.- ECHOES Screen.

Around the main path there is an area in a different colour. This area represents the Guard Interval. If an echo is outside this area can be dangerous for the transmission. In this case it appears a warning message "**ECHOES WARNING**".

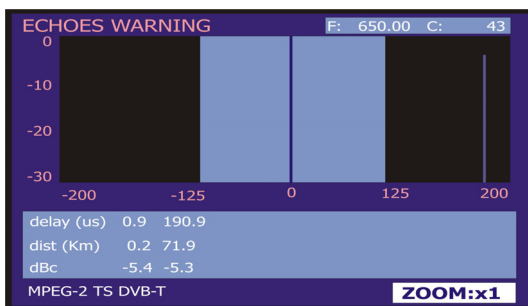





Figure 54.- ECHOES WARNING Screen.

5.18 Screen capture

The user can capture and save different screens in a file, with the aim to process them later. The screens, which can be captured, are the following ones (available according to the model):



1. **Constellation Diagram**
2. **Spectrum analyser**

In order to save a screen, access through the function or operating mode to the  **Utilities** menu [22] and select by means of the rotary selector  [1] the **Save as:** option, later introduce by means of the alphanumeric keyboard [8] the file name of the screen to be captured, and finally confirm it by pressing again the rotary selector  [1].

5.18.1 Recall screen

Accede to the  **Utilities** menu [22] and select one of the following options according to the type of capture that has been carried out:

1. **Recall Constellation** Recall a constellation diagram.
2. **Recall Spectrum** Recall a frequency spectrum graph.

When trying an option by means of the rotary selector  [1] it appears a menu that contains the names of the stored files. Select one using the rotary selector  [1] or press **EXIT**.



The saved spectrum and constellation data can be exported in the form of a text file (CSV). These files can be very useful if they are included in documents such as a spreadsheet, data base, etc. There is a software application to download the files to the PC.

Users can also develop a tailored program to read those files using remote control commands.

5.18.2 Delete capture



Also it is possible to delete the stored screens. For it, accede to the **Utilities** menu  [22] and after activating this function, select one of the following options according to the model and type of capture that has been done:

- constell/** Deletes a constellation diagram.
- sp/** Deletes a frequency spectrum.
- other/** Deletes any other kind of capture.

When pressing with the rotary selector  [1] over the option will appear a menu that contains the names of the stored files. Select one by means of the rotary selector  [1] or press **EXIT**.

5.19 PRINT SCREEN function

It is also possible to save anything that appears on the screen of the meter using the "**PRINT SCREEN**" function. To save an image you only need to press the key  [10] during a few seconds. A file with the screen content in bit map format (bmp) will be generated automatically. These files can be viewed later on using any program that supports .bmp formats.

To delete one or more of the captured images, press  [22] and select **DELETE PRINT SCREEN**. You will see a list of captured screens files. To delete a file, place on it and press the rotary selector  [1]. To delete all stored files place on **ALL** option and press the rotary selector  [1]. A window pops up asking for permission to delete all the screenshots.

NOTE: You cannot use this function in the case of OSD messages.

5.20 VIEWPRINT SCREEN

With this function the user can see the screen that has been captured by using the **PRINT SCREEN** function (previous section).



To access this function press [22] and select **VIEW PRINT SCREEN**. Then there is a list of files names of screens and videos captured. The user can move along this list of the screen captures files by turning the rotary knob and see the image thumbnail. To zoom in, press the rotary knob [1]. Press again the rotary knob to get back to the list of files.

5.21 USB On-the-Go Function

The **TV EXPLORER HD DTMB** has a female mini **USB** port that uses a specific communication protocol called **USB On-The-Go** (OTG abbreviated). This type of communication allows the equipment to work in two different ways depending on the element connected to the **USB** port: as a server (host) or as a device (slave). In general, the **TV EXPLORER HD DTMB** works as a host when connecting a **USB** flash drive and as a slave when connecting to a computer. This function converts the PC into a much more versatile instrument.

5.21.1 Connection of **TV EXPLORER HD DTMB** (host) to a **USB** flash drive (slave)

This option allows you to copy a certain file from the **TV EXPLORER HD DTMB** to the **USB** flash drive or vice versa. To access these options, you should previously connect a **USB** memory device (flash drive, portable hard drive, etc.) to the mini **USB** female port of the instrument. To do this use the **CC-045** cable (Mini **USB** male - female **USB**) supplied with the equipment. When the connection is working, it appears an **USB** icon on the measurement screen (see picture) and the **USB** option becomes available on the Utilities menu.

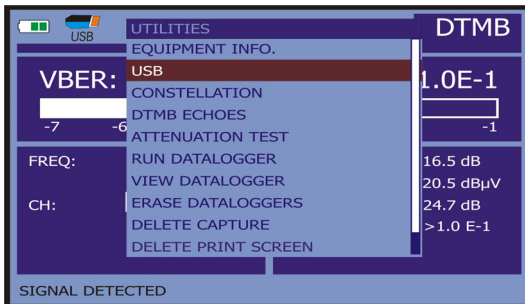





Figure 55.-

The **USB** menu has the following options:

- **Copy To Pendrive.**
- **Get From Pendrive**
- **Copy Streams to Pendrive.**

To scroll through the options press the cursor keys **UP**  [6] or **DOWN**  [6].

To select an option press the rotary selector  [1].

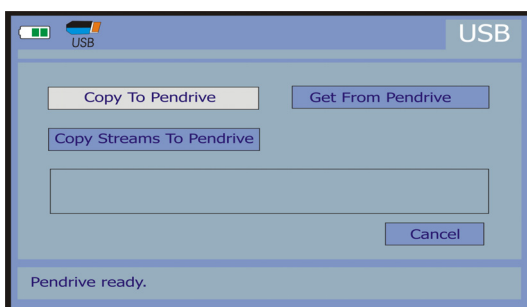

Figure 56.-

Next it is explained every option:

Copy To Pendrive

It copies all files from the memory of the instrument to the memory connected to the **USB** port, except for the video file stream.

When copying files, it also copies the whole structure of folders from the instrument. It creates a general folder called **EXPLORER** and within this folder are the following series of folders:

- CAPTZ:** Here are stored the captures of the MER, the SPECTRUM and others.
- CH:** Here are stored the terrestrial and satellite channels plans.
- DATALOG:** Here are stored the data acquisition files.
- DISEQC:** Here are stored the DiSEqC programs.
- PVR:** Here are stored the TS-ASI video stream.
- SKINS:** Here are stored several colours skins for the screen.
- VAR:** Here are stored the screenshots.

Get From Pendrive

It performs the function opposite to the previous explained one, that is, to copy existing files from **USB** memory to the folders at the **TV EXPLORER HD DTMB** memory. To perform this function is necessary to have the same structure of folders in both **USB** memory and **TV EXPLORER HD DTMB**.

Copy Streams to Pendrive

It copies TS files recorded from a service inside the PVR folder of the pendrive. Normally this is the file that takes up more space and time. For this reason this option is independent of the copy of the rest of files.

5.21.1.1 Connecting a computer (host) to the TV EXPLORER **HD DTMB** (slave)

To connect a **TV EXPLORER HD DTMB** with a computer, you should install the drivers (if they are not installed yet) you have in the folder **USB_DRIVERS**, on the memory support delivered with the instrument. To install drivers follow the steps described in the manual.

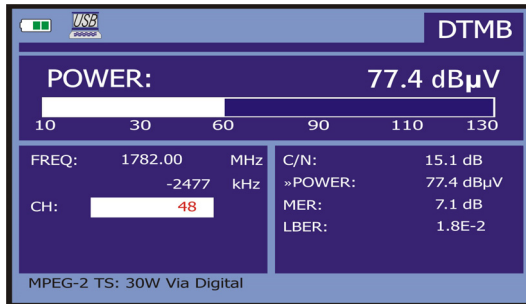

Figure 57.-

Then you have to install the software NetUpdate3, which is also found in the memory support delivered with your equipment. It allows connecting the **TV EXPLORER HD DTMB** and to perform various functions such as create and edit plans, update firmware, etc..

Once installed all the necessary software on your computer, connect the **TV EXPLORER HD DTMB** to the computer by using the **CC-041** (mini USB male – USB male) delivered with the equipment. After connecting, it appears an icon at the top of the measurement screen (Figure 58.-).

Run the program and make the connection with your equipment using the option "Detect" on the program to access all the available features.

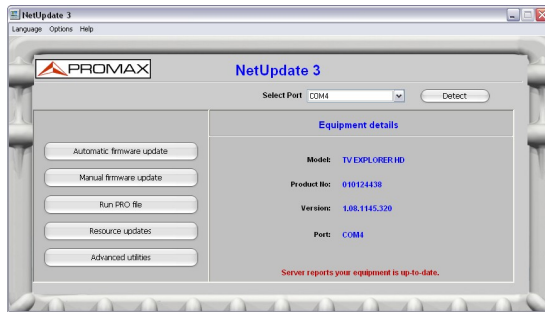



Figure 58.-

5.22 Setting the TS-ASI Input-Output

The **TS-ASI** option is a key feature for a TV analyser. It allows both input and output transport streams. It automatically detects whether the stream is composed of 188 or 204 bytes. It can transmit in packet mode or burst mode.

To configure the **TS-ASI** inputs and outputs, access from the **TV mode** or from the **measurement mode**.

From the TV mode, press the measurement configuration  [17] to access the **SETUP** menu and go to the bottom of the menu until the Enable **ASI INTERFACE**.

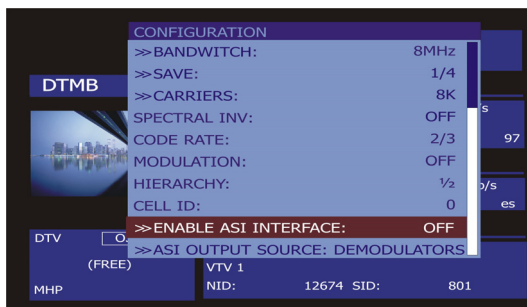

Figure 59.-

Select the option by pressing the rotary and turn it to go from **OFF** to **ON**. Press the rotary to accept the change. There are two new options, which are:

ASI OUTPUT SOURCE

It allows you to select the output signal between two options: **DEMODULATORS** and **AUXILIAR**. The **DEMODULATORS** option uses the **TS** coming from the internal demodulator, which is active at that time. The **AUXILIARY** option uses any video file.

TS INPUT SOURCE

It allows selecting the TS to use in the decoder. The **INTERNAL** option uses the **TS** coming from the internal demodulator of the instrument. The **EXTERNAL** option uses the **TS** connected through the **TS-ASI** input by the user.

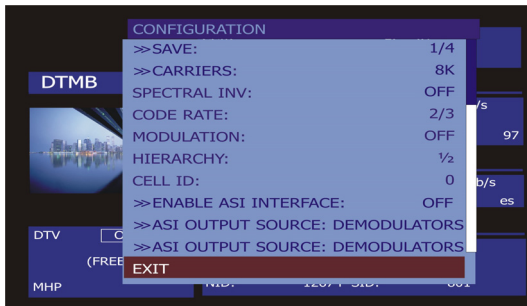



Figure 60.-

You can also access the **TS-ASI** option from the **MEASUREMENT** mode. Press the key for measurement configuration  [17] to access the **SETUP** menu and go to the bottom of the menu until the option **Enable ASI INTERFACE**.

Select the option by pressing the rotary and turn it to switch from **OFF** to **ON**. Press the rotary to accept the change. Now there is a new option:

ASI OUTPUT SOURCE option as explained above, allows selecting the output between two options: **DEMODULATORS** and **AUXILIAR**. The option **DEMODULATORS** uses the **TS** that comes from the internal demodulator which is active at that time. The **AUXILIARY** option uses any video file.

5.23 TV Operating Mode

When pressing the  [10] key from any mode of operation the **TV EXPLORER HD DTMB** accedes to the **TV mode**, and tries to demodulates on the monitor the currently video signal on tune.

In the monitor will appear the TV picture with a window on the lower part to show, for five seconds whenever the signal is analogue; the channel number, the frequency, the active channel set, the colour system, the TV standard and the saturation level (**SYNC OK / SYNC FAIL**).



Figure 61.- Analogue channel monitoring.

If it is a digital television signal (**DTV**) on screen appears, for about some seconds, the following parameters:

The top data box shows the tuned **CHANNEL** data: number or satellite name, frequency, active channel plan and satellite downlink frequency.

The following data box shows the **VIDEO** data: type of video coding (MPEG-2 or MPEG-4), video bit rate, profile and level with its resolution and aspect ratio, video program identifier (**VPID**) and the TS identifier (**TSID**).

Next data box contains **AUDIO** information: type of audio coding (MPEG-1, MPEG-2 or AC-3), audio bit rate, audio program identifier (**APID**) and language (e.g. spa).

The last box located in the same column shows the **NETWORK** data: network name and/or satellite orbital position, service name, network identifier (**NID**) and service identifier (**SID**).

On the left column appears the type of **DVB** signal, a window showing the signal decoded and finally a data box stating if the emission is encrypted or free (**SCRAMB** or **FREE**), when the service supports interactive TV (**MHP**, i.e. *Multimedia Home Platform*) and when is inserted a **CAM** module into the **TV EXPLORER HD DTMB** the indication (**CAM**) appears.

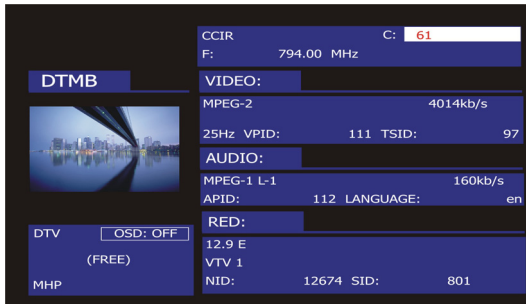









Figure 62.- Digital channel monitoring.

When pressing the cursor arrow  [6] key will appear the tuning information window again, in order to fix on screen this window the vertical cursors  [6] key must be pressed up to select the OSD:OFF field, so press rotary selector  [1] to switch to OSD:ON.

Also the standard **MPEG-2** profile is indicated which determines the compression rate for the digital service decoded, the aspect ratio (**4:3**), the resolution (horizontal x vertical) for received video and the picture refreshment frequency rate. In the (OSD:OFF) mode the information window previously described will appear whenever the rotary selector is pressed again  [1].

When a digital channel is decoded, once the Table of Services **SDT (Service Description Table)** acquisition is completed, is possible to accede to the **list of services** contained in the Table.

For it place the field selector, by means of the vertical cursors  [6] key, on the field of the active service (e.g. *VTV 1* in the following figure) and later press the rotary selector  [1].

The **DIGITAL SERVICES** menu will appear then with the services available in the digital **Multiplex**. Move the vertical cursors  [6] key or turn the rotary selector  [1] and press it to select the service to visualise on screen.

In the list of available services, a service may appear preceded by a symbol, with two possible meanings:

- (*) Indicates that the service is encrypted.
- (#) Indicates that it is an internal service from a provider and it is not supported.

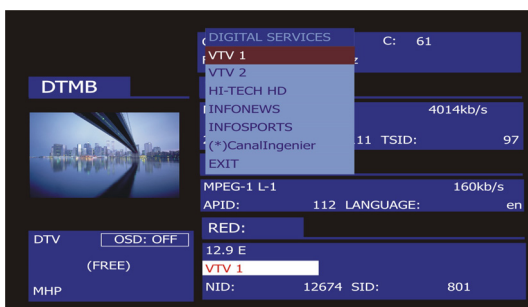















Figure 63.- Digital channel monitoring. Digital services.

Also is possible to change the active service directly acting through the horizontal cursors  [6] key once has selected the field of the service from information window of the currently tuned channel.

On the **TV EXPLORER HD DTMB** screen always the image is visualised according to the option selected from the **Video format** function in the **Measurement**

Configuration  [17] menu and also according to the instrument display features, that is to say, the format conversions are based on a TFT with **16:9** aspect ratio.

Through the **Scart connector** [35] output and for digital signals, it will obtain a video signal according to the format selected by the users (see the following table).

ANALOGUE MODE			
ORIGINAL VIDEO	SELECTED FORMAT	TV EXPLORER HD DTMB SCREEN	SCART CONNECTOR
4:3 	4:3	PILLAR BOX 	4:3 (original) 
4:3 	16:9	FULL SCREEN 	4:3 (original) 
16:9 	4:3	PILLAR BOX 	16:9 (original) 
16:9 	16:9	FULL SCREEN 	16:9 (original) 











DIGITAL MODE			
ORIGINAL VIDEO	SELECTED FORMAT	TV EXPLORER HD DTMB SCREEN	SCART CONNECTOR
4:3 	4:3	PILLAR BOX 	Scaling 4:3 in 16:9 TFT
4:3 	16:9	FULL SCREEN 	4:3 (Original) 
16:9 	4:3	PILLAR BOX 	<i>(Do not select)</i>
16:9 	16:9	FULL SCREEN 	16:9 (Original) 

Table 4.- Selecting the screen and SCART video format.

Therefore, if the original video signal shows 4:3 format and a 4:3-video format is selected for the instrument screen, will appear a PILLAR BOX format and if the 16:9 video format is selected will appear a FULL SCREEN format.



NOTE:

In order to obtain the video signal in the original format through the **Scart connector**, the 16:9 format must be selected from the **Measurements**

Configuration  [17] menu.

5.23.1 Recording and playing video streams

When the display visualises a digital channel with the tuning information (see previous section). Press the **UTILITIES**  [22] key to record or to reproduce a video sequence.

In order to record the channel on tune, press the **UTILITIES**  [22] key and select the option **PVR Recording** by means of the rotary selector  [1]. On the picture will appear the  icon, stating that the channel is being recorded.

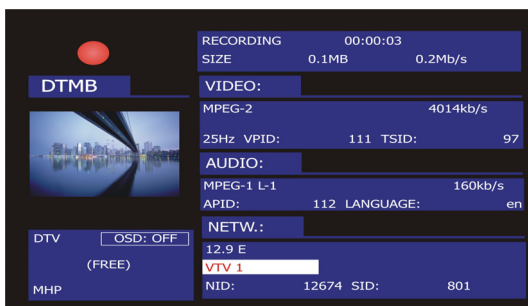







Figure 64.- Digital channel recording.

On screen appears the duration of the recorded sequence, the size that occupies in the internal memory and the transport stream rate. In order to stop the recording press the **UTILITIES**  [22] and select the option **Stop recording**.

In order to play the previously recorded sequence, press the **UTILITIES**  [22] and select the **PVR Playback** option using the rotary selector  [1]. In the image it will appear an icon indicating that the video is being played , the option can be stopped the sequence selecting **Pause Playing**. When is completed, on screen appears the pause  icon. Select the **Stop Playing** option to back to the tuned channel viewing.

5.24 Antenna Alignment Function

Pressing the key  [23] you access the function **Antenna Alignment** in order to align antennas using a faster sweep without display of numerical measures. The display appears divided in two parts, the left one shows the spectrum of the signals detected in the band and on the right two analogue bars represents the more high signal level found during the last carried out sweeping. The left bar shows the peak value with a certain persistence. The right bar shows a filtered average value.

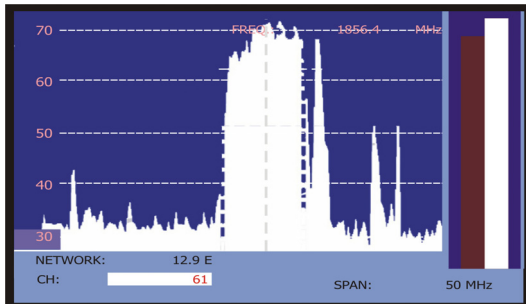





Figure 65.- Utility for antenna alignment.

Simultaneously the instrument emits by means of the loudspeaker an acoustic tone, which varies according to the level of received signal.

Press the  [24] key to switch between tuning by frequency or by channel.

Turn the rotary selector  [1] to change frequency or channel.

To modify the **SPAN** use the cursor arrow left or right  [6].



To move the Gain vertical axis press the cursor arrow up or down  [6].

Hold the up arrow  [6] for half a second to change the vertical axis to 10 dB per division.

Hold the down arrow  [6] for half a second to change the vertical axis to 5 dB per division.

5.25 DiSEqC Command Generator

DiSEqC⁸ (*Digital Satellite Equipment Control*) is a communication protocol between the satellite receiver and the accessories of the installation (switches, LNBs, etc.) proposed by Eutelsat, with the aim to standardize the diversity of switching protocols (13 - 18 V, 22 kHz) and to satisfy the demands of the digital TV installations.

In order to define and/or to send a sequence of DiSEqC commands, press the  DiSEqC key [21] on frontal panel. It allows to define the satellite band configuration parameters and select through SEND function one of the eight predefined programs which execute basic functions to control an universal switch with two or four inputs, by means of the rotary selector  [1].

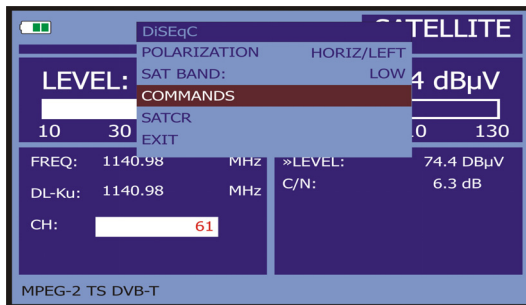

Figure 66.- DiSEqC command screen.



Whenever a DiSEqC program is sent, the commands that correspond to the equipment status in relation to the Horizontal or Vertical polarization and High or Low frequency band are also sent. This allows assuring that the installation status is the one indicated by the equipment.

⁸ DiSEqCTM is a trademark of EUTELSAT.

The **COMMANDS** option from **DiSEqC** menu allows to execute any of the following commands:

CHARACTER	COMMAND	ASSOCIATED PARAMETER
General	POWER	---
	RESET	---
	STANDBY	---
	SAT A/B	A / B
Non-assigned Switch	SWITCH 1	A / B
	SWITCH 2	A / B
	SWITCH 3	A / B
	SWITCH 4	A / B
Assigned Switch	POSITION A/B	A / B
	SWITCH OPTION A/B	A / B
Positioner	DISABLE LIMITS	---
	ENABLE LIMITS	---
	LIMIT EAST	---
	LIMIT WEST	---
	DRIVE EAST SEC.	1 to 127
	DRIVE EAST STEPS	1 to 127
	DRIVE WEST SEC.	1 to 127
	DRIVE WEST STEPS	1 to 127
	GOTO POSITION	1 to 255
	HALT	---
	STORE POSITION	1 to 255
	RECALCULATE	1 to 255

Table 5.- Available DiSEqC commands.

When selecting the **COMMANDS** option in the **Spectrum Analyser** mode ⁴  [13] in the screen will appear a dynamic execution line in order to use with the positioner commands: **DRIVE EAST / WEST**. This allows to carry out a fine adjustment in steps or in seconds to aim the antenna through the rotary selector  [1].

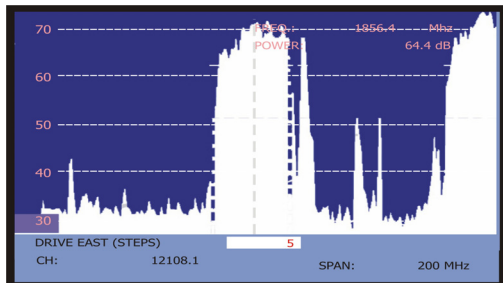





Figure 67.- DiSEqC commands: DRIVE

Press the **DiSEqC** key ⁷  [21] on frontal panel in order to quit the commands execution mode and to locate the mark cursor on the frequency or channel.

5.26 SATCR function

By means of function **SATCR** it is possible to control the devices of a TV installation satellite that are compatible with the SatCR⁹ technology (Satellite Channel Router), which allows to concentrate manifold down frequencies (slots) by an only cable. By this way each user using a slot can tune and decode any signal present in the satellite.

In order to select the **SATCR** function, press the DiSEqC key  [21] from frontal panel, and using the rotary selector  [1] activate the **SATCR** option. In the display are the configuration options that users can modify: slot selection, number of slots, device address, Frequency sep, pilot signal activation, and finally the frequencies corresponding to each slot.

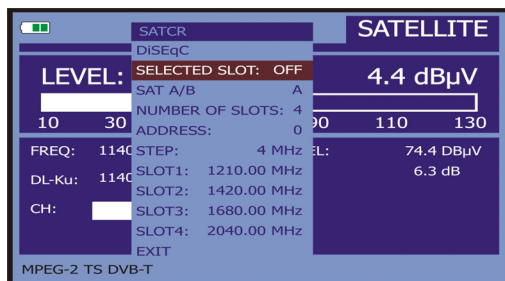

Figure 68.- SatCR command screen.



When activating the **Enable Pilots** options, the SatCR device located in the headend emits a pilot signal with constant level for each down frequency (*slot*). This function facilitates the verification and identification for different satellite channels that are available in the installation. The SatCR technology is being developed and tested in many countries.



5.27 Using the alphanumeric keyboard

In order to enter numerical data or text the built in alphanumeric keyboard must be used. Many keys incorporate a number and several letters like the telephone keypad.

⁹ SatCR is a trademark of STMicroelectronics.

1) Entering numerical data: (e.g.: a channel frequency).

Press the key corresponding to the digit that you wish to enter (from the 0 to the 9). When pressing the decimal point  [17] key it enters the character point and later the equipment allows entering two more digits. In order to introduce a negative number first press the  [24] key until the sign - appears.

In order to erase a digit move with the horizontal cursors  [6] key placing the cursor behind the digit that is desired to erase and later keep  [17] key pressed until the digit disappears. Repeat the operation by each additional digit you wish to eliminate.

Once deleted the first digit, when keeping pressed the  [17] key erases the rest of characters from field.

2) Entering alphanumeric data: (e.g.: a channel plan name).

Press the corresponding key of the keyboard [8] letter or digit to be entered.

The word to be entered can be written by pressing each key. The keys must be pressed, two seconds before and for a suitable number of times, until it appears the expected letter or digit on screen. In order to switch between small letters to capital letters and vice versa, first press the  key [25].

Note: Press the upper arrow cursor  [6] key to cancel any data entry through the keyboard.



When maintaining pressed a numerical key in text mode, the corresponding number is directly entered.

6 DESCRIPTION OF THE INPUTS AND OUTPUTS

6.1 RF input

The **RF** input is through the **RF**  [30] connector on the side panel. The peak signal level should never exceed 130 dB μ V.

6.2 TS-ASI Input / Output

The **TS-ASI** input / output signals works through the connectors  [42] (input),  [43] (output) at the rear panel.

6.3 USB port

The **TV EXPLORER HD DTMB** incorporates an “**USB On-the-go**” port, which enables the communication with a PC, and to download dataloggers and channel plans.



Figure 69.- “**USB On-the-go**” connector in rear panel. External view.

The “**USB On-the-go**” makes it possible for two **USB** devices to communicate with each other without requiring a separate **USB** host. In practice, one of the **USB** devices acts as a host for the other device.

6.4 HDMI Conector (High-Definition Multimedia-Interface)

HDMI (High-Definition Multimedia Interface) is a compact audio/video interface for transmitting uncompressed digital data. **HDMI** supports, on a single cable, any TV or PC video format, including standard, enhanced, and high-definition video; up to 8 channels of digital audio; and a Consumer Electronics Control (CEC) connection. The CEC allows **HDMI** devices to control each other when necessary and allows the user to operate multiple devices with one remote control handset.



Figure 70.- **HDMI** Connector at the rear panel. External view.

6.5 Scart (DIN EN 50049)

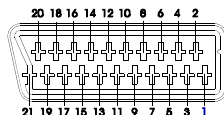



Figure 71.- Scart socket (external view).

Also known as PERITEL connector (in conformity with standard NF-C92250). The signals in this connector are the following:

PIN number	SIGNAL	CHARACTERISTICS
1	Right channel audio output	
2	Right channel audio input	
3	Left channel audio output	
4	Audio grounding	
5	Blue grounding (B)	
6	Left channel audio input	
7	Blue output (B)	
8	Switching voltage	
9	Green grounding (G)	
10	Digital bus interface	(not connected)
11	Green output (G)	
12	Digital bus interface	(not connected)
13	Red grounding (R)	
14	Digital bus reserved	(not connected)
15	Red output (R)	
16	Blanked signal	(not connected)
17	Composite video grounding	
18	Blanked return	(not connected)
19	Composite video output	
20	Video input	
21	Connector shield grounding	

Table 6.- Description of the Scart.

NOTE: In order to select the **SCART** connector operation mode between: video **Input**, video **Output** or **Automatic**, from the **TV** visualisation mode [10] in terrestrial band, follow the following steps:

1) Select the **Measurement Configuration** menu by pressing the  [17]

2) Select the suitable operation mode for the SCART by means of the **Video/Aud Ext** option in this menu.



6.6 Connector for CAM modules and SMART-CARD.

Enables the conditional access (decryption) of encoded digital TV signals, in agreement with the **DVB-CI** (*Common Interface*) recommendation.

This technology supports all those decryption systems for which a valid **CAM** module exists, according to **DVB-CI**, with the corresponding subscriber card.

The **TV EXPLORER HD DTMB** by means of **Common Interface** method offers the possibility of supporting various conditional access systems, so that video and/or audio broadcast by encrypted services (scrambled TV for subscribers) may be decoded following the **SimulCrypt** model. It provides a standard connector to insert **CAM** modules (Conditional Access Module), which allows a specific management for each codification system.

SimulCrypt is a process supports various parallel conditional access systems, together with the encryption algorithms specified by **DVB-CSA** (*Common Scrambling Algorithm*) to control access to pay-TV services. The **SimulCrypt** broadcasts **Transport Stream** contains keys for various conditional accesses, thereby allowing reception by more than one type of decoder.

The user just needs to insert the subscriber Smart-Card in the **CAM** module connector designed for this purpose. When a **CAM** module has been inserted and the instrument is in the **digital TV operation mode**, accede to the **Measurement configuration** menu by pressing the  [17] key and select the **COMMON INTERFACE** option. By means of this option the user can navigate through the **CAM** module menu. Whenever an option is selected, the waiting  icon appears until the module allows accessing to the next menu or to the option selected.

In order to insert or to change one **CAM** module, follow these steps:

- The **CAM** module connector [38] is located on the equipment rear panel. Place the instrument on a stable surface and insert the module so the printed arrow appears on visible upper face, pressing until the extractor mechanism button [39] becomes activated.

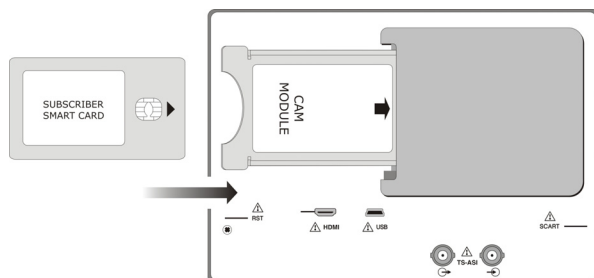

Figure 72.- Subscriber Smart-Card and CAM module insertion.

- To extract an inserted **CAM** module, press the button from extractor mechanism [39] and remove the module.

IMPORTANT REMARK

The insertion of a CAM module or a SMART-CARD in a wrong position might produce the instrument malfunction and could generate damages to the equipment.

7 MAINTENANCE

7.1 Considerations about the Screen.

This paragraph offers key considerations regarding the use of the colour screen, taken from the specifications of the manufacturer.

In the TFT display, the user may find pixels that do not light up or pixels that are permanently lit. This should not be regarded as a defect in the TFT. In accordance with the manufacturer quality standard, 9 pixels with these characteristics are considered admissible.

Pixels which are not detected when the distance from the surface of the TFT screen to the human eye is greater than 35 cm, with a viewing angle of 90° between the eye and the screen should not be considered manufacturing defects either.

It is advisable a viewing angle of 15 ° in the 6.00 o'clock direction in order to obtain the optimum visualization of the screen.

7.2 Cleaning Recommendations

CAUTION

To clean the cover, take care the instrument is disconnected.

CAUTION

Do not use scented hydrocarbons or chlorized solvents. Such products may attack the plastics used in the construction of the cover.

The cover should be cleaned by means of a light solution of detergent and water applied with a soft cloth.

Dry thoroughly before using the system again.

CAUTION

Do not use for the cleaning of the front panel and particularly the viewfinders, alcohol or its derivatives, these products can attack the mechanical properties of the materials and diminish their useful time of life.

